

Laser Measuring Tools and Environmental Measuring Instruments

Precision products 2022



geo
FENNEL

LINE LASERS	6
Outline Line Lasers	8
Cross Line Lasers	10
Cross Line Lasers with additional functions	14
Multi-Line Lasers	16
Line Lasers for floor work	26
Receivers for Line Lasers	28
Accessoires	29
ROTATING LASERS	30
Outline Rotating Lasers	32
Indoor Use	34
Indoor and Outdoor Use	40
Outdoor Use	46
Receivers for Rotating Lasers	60
Machine Control Receivers	62
ACCESSORIES FOR ROTATING AND LINE LASERS	64
PIPE LASERS	70

SURVEYING INSTRUMENTS	76
Automatic Level	78
Engineers' Automatic Level	79
Electronic Theodolites	80
Construction Theodolite	81
GNSS Systems	82
LASER DISTANCE METERS	
Outline Laser Distance Meters	86
MEASURING INSTRUMENTS	92
Measuring Wheels	94
Measuring Tapes	95
Electronic Slope Measurers	96
Digital Plan Measurer	97
Electronic Angle and Slope Measurers	97
Rules	98
Positioning Lasers	99

Thermal Imaging Camera and Temperature/ Humidity Meters

ENVIRONMENTAL INSTRUMENTS	100
Environmental Measuring Instruments	102
Video Borescopes	104
Infrared Thermometers	105
Thermal Imaging Camera	106
Temperature / Humidity Meters	106
Moisture Meters and Detector	107
Various	108
Measuring Probes	109
TRIPODS AND LEVELLING STAFFS	110
Elevating Tripods, light	112
Elevating Tripods, heavy	113
Universal Tripods	114
Wooden Tripods	115
Ranging Poles	115
Telescopic Levelling Staffs	116
ACCESSORIES	118
Marking Spray	120
Two-way Radio	120
Surveyors' Folding Frames	120
Optical Squares	121

MIXERS	122
Mixers	124
Mixer Rods and Extentions	125
QUALITY AND SERVICE	126
Quality and Service	128
Technical Information	130
Sales Displays	134
Presentation Systems	135
Sales Support	136

geo-FENNEL Innovations 2022

Innovation from tradition

Here it is: our geo-FENNEL catalogue 2022 and alongside its clever new products for the construction site. Some of these novelties we really want to recommend to you.

By the way: You know us as a strong partner in the surveying field. Our range of GPS systems and total stations can be examined in our separate surveying catalogue.

More information about us and our products on our website:
www.geo-fennel.com

**NEW
2022**

LINE LASERS
CROSS LINE LASERS



GEO1X-GREEN
PAGE 10

LINE LASERS
MULTI-LINE LASERS



FLG 66-XTREME GREEN + SP
PAGE 16

LINE LASERS
MULTI-LINE LASERS



GEO4-XR GREEN
PAGE 18

LINE LASERS
MULTI-LINE LASERS



FLG 70 GREEN SP
PAGE 24

ACCESSORIES FOR
ROTATING AND LINE LASERS



MOUNT MH1
PAGE 66

ACCESSORIES FOR
ROTATING AND LINE LASERS



WALL MOUNT LH 1
PAGE 67

SURVEYING INSTRUMENTS



FET 220K-L
PAGE 80

LASER DISTANCE METERS



GEODIST 60-GREEN
PAGE 88

LASER DISTANCE METERS



GEODIST 80
PAGE 88

LASER DISTANCE METERS



GEODIST 100-TOUCH
PAGE 88

ENVIRONMENTAL MEASURING
INSTRUMENTS



FWS 80
PAGE 100

MIXERS



FM 1200
PAGE 124

LINE LASERS

Precision in every aspect:
our all-rounders.

Every single device in our range of line lasers is a winner. We provide individual products that are exactly adapted to your particular needs.

As different as these demands may be, one thing is true for all geo-FENNEL line lasers: They consistently impress users with a high degree of precision and guarantee you the best measurement results – in every situation.



	CROSS LINE LASERS			CROSS LINE LASERS WITH ADDITIONAL FUNCTIONS	
	GEO1X-GREEN	FL 40-POWERCROSS PLUS SP	FLG 40-POWER-CROSS PLUS GREEN SP	GEO1X-360 GREEN	CROSSPOINTER5 GREEN SP
Laser class	 2	 2	 2	 2	 2
Scheme of projected lines					
Vertical lines	1	1	1	1	1
Horizontal laser range / angle	360°	135°	135°	360°	180°
Laser points	-	-	-	-	5
Plumb down beam	-	-	-	-	yes
Accuracy / 10 m	± 3 mm	± 3 mm	± 3 mm	± 3 mm	± 3 mm
Dust / water protection	IP 54	IP 54	IP 54	IP 54	IP 54
Working range w/o receiver (radius)	30 m	30 m	40 m	30 m	50 m
Working range with receiver (radius)	60 m	80 m	100 m	50 m	80 m
Power supply	Alkaline	Alkaline	Alkaline	Alkaline	Li-Ion
Receiver	optional	optional	optional	optional	optional
Page	10	12	12	13	14

	MULTI-LINE LASERS							LINE LASERS for FLOOR WORK	
	FLG 66-XTREME GREEN + SP	GEO4-XR GREEN	GEO6-XR GREEN SP	GEO6X SP	GEO6X SP KIT	GEO6X SP GREEN KIT	FLG 70-GREEN SP	GEOSPIDER GREEN	SQUARE LINER II
Laser class	 2	 2	 2	 2	 2	 2	 2	 2	 2
Scheme of projected lines									
Vertical lines	4	2	4	4	4	4	4	-	-
Horizontal laser range / angle	130°	360°	360°	360°	360°	360°	360°	-	-
Laser points	-	-	-	-	-	-	-	-	-
Plumb down beam	yes	yes	yes	yes	yes	yes	yes	-	-
Accuracy / 10 m	± 2 mm	± 2 mm	± 2 mm	± 2 mm	± 2 mm	± 2 mm	± 1 mm	± 3 mm	± 3 mm
Dust / water protection	IP 65	IP 54	IP 54	IP 54	IP 54	IP 54	IP 54	IP 52	IP 52
Working range w/o receiver (radius)	40 m	30 m	40 m	30 m	30 m	40 m	30 m	20 m	10 m
Working range with receiver (radius)	100 m	60 m	60 m	60 m	60 m	70 m	80 m	-	-
Power supply	Li-Ion	Li-Ion	Li-Ion	Alkaline	Li-Ion	Li-Ion	Li-Ion	Alkaline	Alkaline
Receiver	optional	optional	optional	optional	optional	optional	inclusive	-	-
Page	16	18	20	22	22	22	24	26	27

Simply green.
For the **professional entry**.

10



Geo1X-GREEN

Cross line laser with clearly visible green laser lines. Robust rubberised housing, easy operation - the ideal partner for levelling work indoors. The self-levelling function can be locked for manual (slope) use.

DESCRIPTION

- A vertical and horizontal line combine to form a laser cross
- Self-levelling function can be locked for manual use
- Visual / acoustic alarm when out of self-levelling range
- Wall / tripod mount
- magnets on back side
- screw hole for wall-attachment
- 1/4" and 5/8" connection
- Use with receiver FR 75-MM / FR 55 / FR 55-M (optional)

TECHNICAL SPECIFICATIONS

TECHNICAL SPECIFICATIONS	GEO1X-GREEN / SET
Accuracy	± 3 mm / 10 m
Working range without receiver	30 m* (radius)
Working range with receiver	60 m (radius)
Power supply	4 x AA alkaline



All details at geo-fennel.com

*depending on room brightness



Geo1X-GREEN

Supplied with

4 x AA alkaline battery, wall / tripod mount, padded carrying case



Art.-No.: 541250

Set Charger and Li-Ion Battery

for Geo1X-GREEN



Art.-No.: 541251

Geo1X-GREEN SET

Supplied with

4 x AA alkaline battery, wall / tripod mount, elevating tripod, padded carrying case



Art.-No.: 541260

Suitable Accessoires:



RECEIVER FOR LINE LASERS FR 55-M
Art.-No.: 500520

For red and green line lasers.



FLOOR-TO-CEILING PILLAR KS 3
Art.-No.: 520100

Floor-to-ceiling pillar (1-leg tripod) to be fixed between floor and ceiling.



ELEVATING TRIPOD FS 10
Art.-No.: 302000

Lightweight elevating tripod made of aluminium for instruments with 5/8" thread.

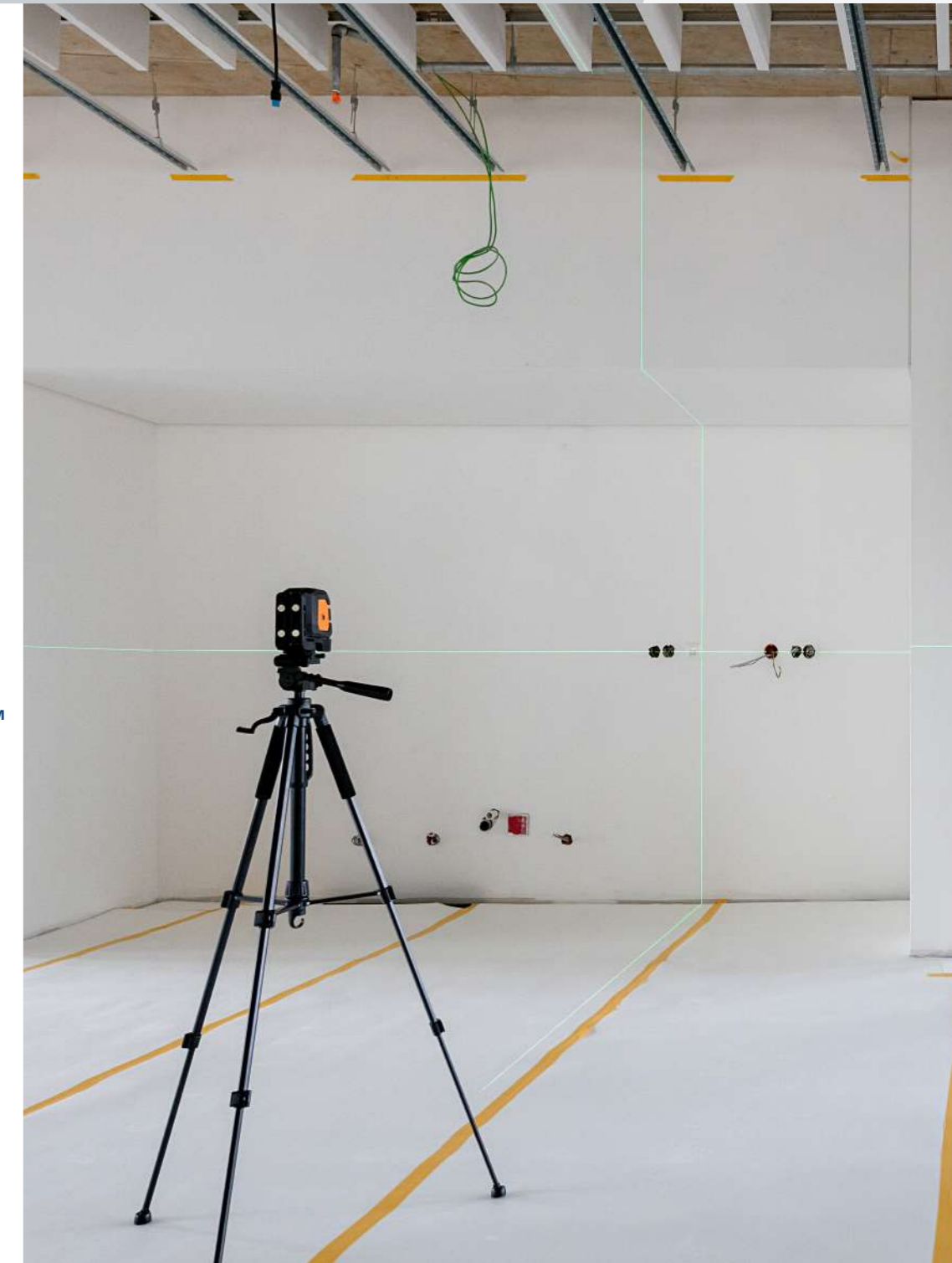

Extremely robust Cross Line Laser with special features

12



FL 40-PowerCross PLUS SP & FLG 40-PowerCross PLUS GREEN SP

FL 40 PowerCross Plus SP and FLG 40-PowerCross Plus GREEN SP are Selection PRO products with special features.

Outstanding visibility of the laser lines. Very long vertical line with 150° fan angle (beyond zenith). Pulse-function for use with receiver (optional). Self-levelling function can be switched off for manual use. Extremely rugged design for rough use at construction site. Product withstands drop up to 1m.

DESCRIPTION FL 40-POWERCROSS PLUS SP & FLG 40-POWERCROSS PLUS GREEN SP

- 1 Laser cross
- Laser lines switchable separately
- TILT function for manual use
- Visual alarm when out of level
- Use with receiver FR 75-MM / FR 55 / 55-M (optional)

- Multi-functional mount
- height adjustable
- for wall-hanging with screw
- strap attachment
- strong magnet on back side
- for tripod fixing with 5/8" or 1/4" thread

TECHNICAL SPECIFICATIONS

	FL 40-POWERCROSS PLUS SP	FLG 40-POWERCROSS PLUS GREEN SP
Accuracy	± 3 mm / 10 m	± 3 mm / 10 m
Working range without receiver	30 m * (radius)	40 m * (radius)
Working range with receiver	80 m (radius)	100 m (radius)
Power supply	4 x AA alkaline	4 x AA alkaline
	IP 54 20 h	IP 54 9 h

All details at geo-fennel.com

*depending on room brightness

FL 40-PowerCross Plus SP

Supplied with
Multi-functional mount, 4 x AA alkaline battery, padded bag

Art.-No.: 541510

Set Charger and Li-Ion Battery

for FL 40-PowerCross Plus SP

Art.-No.: 541511

FLG 40-PowerCross Plus GREEN SP

Supplied with
Multi-functional mount, 4 x AA alkaline battery, padded bag

Art.-No.: 541560

Set Charger and Li-Ion Battery

for FLG 40-PowerCross Plus GREEN SP

Art.-No.: 541561

Suitable Accessoires:



FLOOR-TO-CEILING PILLAR KS 3

Art.-No.: 520100

Floor-to-ceiling pillar (1-leg tripod) to be fixed between floor and ceiling.



ELEVATING TRIPOD FS 10

Art.-No.: 302000

Lightweight elevating tripod made of aluminium for instruments with 5/8" thread.



ELEVATING TRIPOD FS 13

Art.-No.: 304000

Lightweight elevating tripod made of aluminium for instruments with 5/8" thread.



RECEIVER FR 55

Art.-No.: 500510

For line lasers using a red or green laser beam.



Multifunctional for diverse levelling applications at indoor constructions.



GEO1X-360 GREEN

Self-levelling function can be switched off for manual use. Pulse-function to extend working range with receiver (optional).



CrossPointer5 GREEN SP

A self-levelling GREEN line laser with outstanding line visibility up to 50. This combination of a 5 point and cross line laser projects 6 reference points at 90° to each other. Horizontal line with 180° fan angle intersects left / right points, vertical line with 160° fan angle (beyond the zenith point). Laser points rotate 360° around vertical axis. Pulse-function to extend working range with receiver (optional).

14

DESCRIPTION GEO1X-360 GREEN

- 1 Laser cross, 1 x 360° horizontal laser line
- Laser lines switchable separately
- TILT function for manual use
- Visual alarm when out of level
- 1/4" and 5/8" thread for use with tripods etc.

DESCRIPTION CROSSPOINTERS5 GREEN SP

- 2 laser lines form a green laser cross
- 5 laser points: back, left, right, ceiling, floor
- Laser points rotate 360° around vertical axis
- Self-levelling function can be switched off for manual use
- Audible & visual alarm when out of level
- Use with receiver FR 75-MM / FR 55 / 55-M (optional)
- Multi-functional mount
 - height adjustable
 - for wall-hanging with screw
 - strap attachment
 - strong magnets on back face
- 1/4" and 5/8" thread for use with tripods etc.

TECHNICAL SPECIFICATIONS

	GEO1X-360 GREEN	CROSSPOINTERS5 GREEN SP
Accuracy	± 3 mm / 10 m	± 3 mm / 10 m
Working range without receiver	40 m * (radius)	50 m * (radius)
Working range with receiver	60 m ** (radius)	80 m (radius)
Power supply	4 x AA alkaline	Li-Ion
	IP 54 5 h	IP 54 6-24 h

All details at geo-fennel.com

*depending on room brightness
**depending on the alignment of the laser

GEO1X-360 GREEN

Supplied with
Multi-functional mount, 4x AA alkaline battery + case, padded bag



Art.-No.: 533100

CrossPointer5 GREEN SP

Supplied with
Multi-functional mount, Li-Ion battery, intelligent charger + USB cable, case for alkaline batteries, magnetic target, container



Art.-No.: 531550

Suitable Accessoires:



FLOOR-TO-CEILING PILLAR KS 3
Art.-No.: 520100

Floor-to-ceiling pillar (1-leg tripod) to be fixed between floor and ceiling.



ELEVATING TRIPOD FS 10
Art.-No.: 302000

Lightweight elevating tripod made of aluminium for instruments with 5/8" thread.



GRADE MOUNT
Art.-No.: 290700

For rotating and line lasers with manual function. For setting slopes between 0 - 90°.



360° FINE ADJUSTMENT BRACKET
Art.-No.: 290760

Allows a smooth 360° rotation and fine adjustment for rotating and line lasers.



RECEIVER FR 55
Art.-No.: 500510

For line lasers using a red or green laser beam.



Multifunctional for diverse levelling applications at **indoor constructions**.



**NEW
2022**

FLG 66-Xtreme GREEN + SP

This type of 3-foot multi-line lasers were common for many years before 3-head lasers took over the field. But one must not forget that this type has some unbeatable advantages!

Excellent visibility and clear narrow laser lines due to 1 laser diode per direction. The most powerful solution for line lasers. Indoor & outdoor use due to protection class IP 65. Use in humid or dusty indoor and outdoor areas - no problem!

3-foot design for 360° rotation around the vertical axis. Fine adjustment drive and adjustable 360° circle for exact alignment. Wide-span floor tripod with height-adjustable feet for positioning above floor rail with plumb point and laser line on the edge. Powerful Li-Ion battery with 8 hours runtime with all laser lines switched on! ... and if all else fails, the battery charger also serves as a continuous power supply.

FLG 66-Xtreme GREEN + SP

Supplied with

Li-Ion batteries, charger, alkaline battery box, laser intensive glasses, magnetic target, container



Art.-No.: 580551

Suitable Accessoires:



RECEIVER FR 75-MM

Art.-No.: 257200

For line lasers using a red or green laser beam.



ELEVATING TRIPOD FS 13

Art.-No.: 304000

Lightweight elevating tripod made of aluminium for instruments with 5/8" thread.



DESCRIPTION

- 4 vertical lines at 90° to each other, 1 horizontal line 130°
- Plumb down beam
- Laser lines switchable separately
- Self-levelling function can be locked for manual use (inclined applications)
- Audible and visible alarm when out of level
- Detachable floor tripod
- Slow motion screw for horizontal alignment
- Rotatable 360° circle
- 5/8" tripod thread

TECHNICAL SPECIFICATIONS

FLG 66-XTREME GREEN + SP

Self-levelling range	± 3°
Accuracy	± 2 mm / 10 m
Working range without receiver	30 m* (radius)
Working range with receiver	200 m (radius)
Power supply	Li-Ion



All details at geo-fennel.com

*depending on room brightness
**depending on the alignment of the laser

Our entry into the class of
Multi-Line Lasers. Home: floor.

**NEW
2022**



GEO4-XR GREEN

A proven laser product - now rethought and improved 360° horizontal and 2 vertical lines for versatile levelling and right angle alignment. Green laser lines for best visibility. Innovative - standing and hanging application for best possible use. Compact with a wide range of useful accessories.

Alignment of right angles on floor, wall and ceiling and ideal for cutting checks. Standing and hanging application for best possible use. Alignment and verification of the correct height of the floor covering. 20 mm adapter for fixed height of 20 mm between floor and horizontal line.

Geo4-XR GREEN

Supplied with

Li-Ion battery, intelligent charger and USB 3.0 cable, battery case for alkaline batteries, multi-functional mount, 20 mm fixed height adaptor with 1/4", 2x height measurement pins, padded bag



Art.-No.: 533150

Suitable Accessoires:



FLOOR-TO-CEILING PILLAR KS 3

Art.-No.: 520100

Floor-to-ceiling pillar (1-leg tripod) to be fixed between floor and ceiling.



ELEVATING TRIPOD FS 10

Art.-No.: 302000

Lightweight elevating tripod made of aluminium for instruments with 5/8" thread.



GRADE MOUNT

Art.-No.: 290700

For rotating and line lasers with manual function. For setting slopes between 0 - 90°.



360° FINE ADJUSTMENT BRACKET

Art.-No.: 290760

Allows a smooth 360° rotation and fine adjustment for rotating and line lasers.



RECEIVER FR 55

Art.-No.: 500510

For line lasers using a red or green laser beam.



RECEIVER FR 75-MM

Art.-No.: 257200

For line lasers using a red or green laser beam.



WALL MOUNT LH1

Art.-No.: 290616

Adapter for wall fixing.

18

DESCRIPTION

- 360° horizontal line, 2 vertical lines 130° form 4 laser crosses
- Laser lines switchable separately
- Plumbing function (laser cross at floor & ceiling)
- 8 mm minimum distance of horizontal laser line to the floor
- Visual and audible alarm when out of level
- Self-levelling function can be locked for manual use
- Tripod connection top and bottom 1/4" (bottom side with adapter)
- Use with receiver FR 75-MM / FR 55 (optional)

TECHNICAL SPECIFICATIONS

GEO4-XR GREEN

Self-levelling range	± 3°
Accuracy	± 2 mm / 10 m
Working range without receiver	30 m* (radius)
Working range with receiver	60 m ** (radius)
Power supply	Li-Ion



IP 54



9 h

All details at geo-fennel.com

*depending on room brightness
**depending on the alignment of the laser

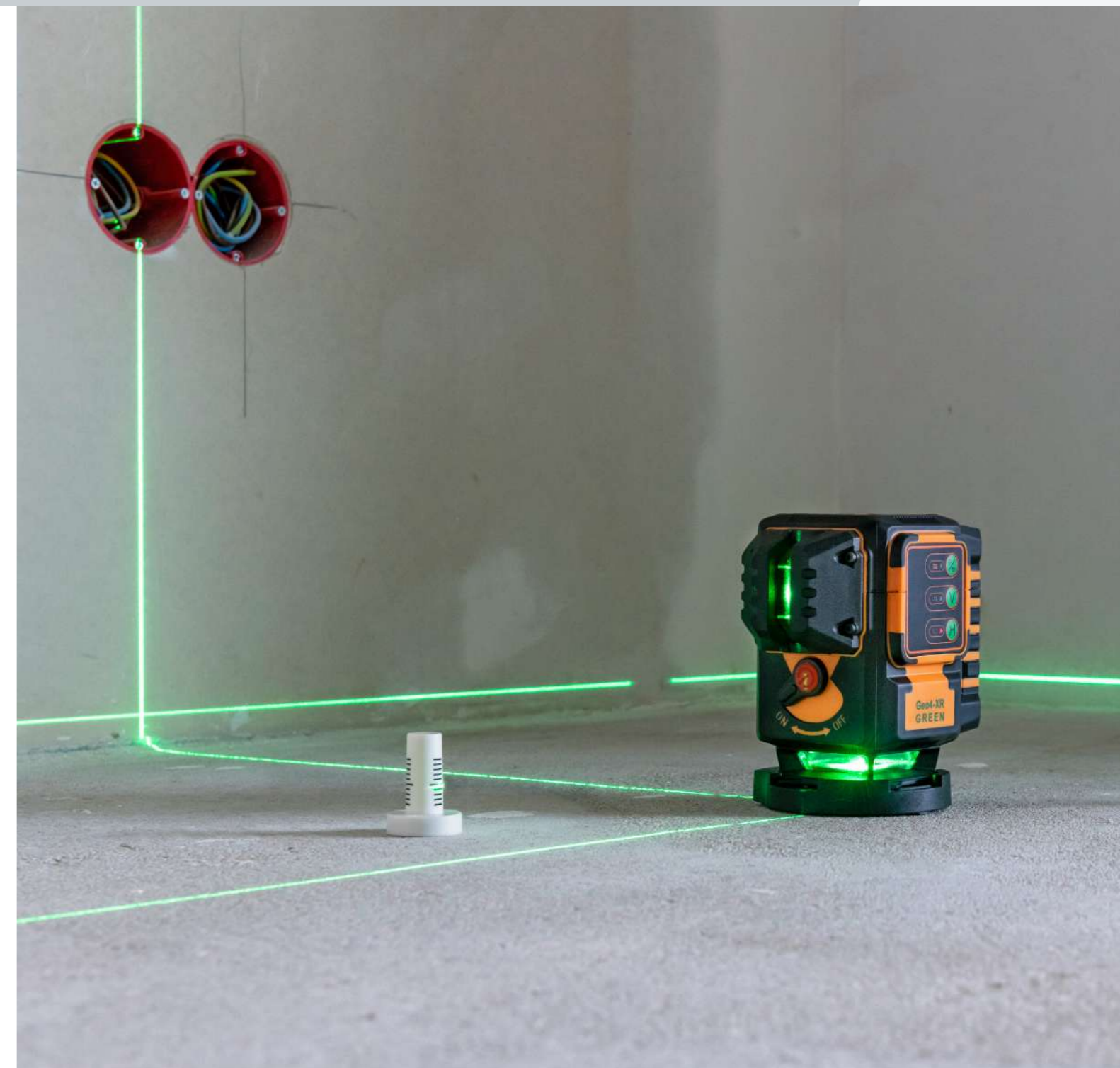

Multi-Line Lasers in the premium segment - floor plus.



20

DESCRIPTION

- 3 x 360°-Laser lines - form 6 laser crosses
- Laser lines switchable separately
- Plumbing function
- Minimum laser line distance to floor 8 mm
- Minimum laser line distance to wall 6 mm
- Height adjustable platform from 25 to 85 mm
- Visual and audible alarm when out of level
- Self-levelling function can be locked for manual use
- Thread 5/8" and 1/4"

TECHNICAL SPECIFICATIONS

	GEO6-XR GREEN SP
Accuracy	± 2 mm / 10 m
Working range without receiver	40 m* (radius)
Working range with receiver	60 m** (radius)
Power supply	Li-Ion

All details at geo-fennel.com

*depending on room brightness
**depending on the alignment of the laser



IP 54



5 - 15 h



GEO6-XR GREEN SP

3x 360° highly visible green laser lines all perpendicular to each other. Projecting right angles everywhere at the floor for straight and diagonal laying of tiles. Alignment and verification of correct floor height. Checking level, flatness and parallelism of walls and floors.

3 x 360° green laser lines - visible up to 40 m. 6 mm minimum distance of the laser line to the wall. 8 mm minimum distance of the laser line to the floor. Height adjustable platform with a range from 25 to 85 mm. For precise height control when setting out floor coverings. 20 mm fixed height adapter with 5/8" thread. Height adjustable wall-mount with swivel-mount support rail. Optimise floor tile layout with free-hanging tripod mount. Monitor and correct floor levels using the height measurement pins. Pulse-function to extend working range with receiver (optional).

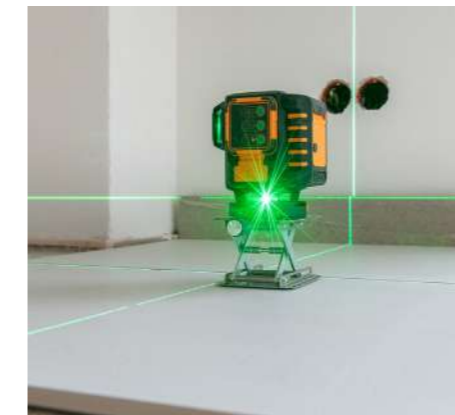

Geo6-XR GREEN SP

Supplied with

Li-Ion battery, intelligent charger with USB 3.0 cable, battery case for alkaline batteries, height adjustable platform, wall-mount, support rail, 20 mm fixed height adapter with 5/8", 3x height measurement pins, magnetic target, container



Art.-No.: 533200

Suitable Accessoires:

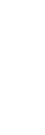

FLOOR-TO-CEILING PILLAR KS 3

Art.-No.: 520100

Floor-to-ceiling pillar (1-leg tripod) to be fixed between floor and ceiling.



ELEVATING TRIPOD FS 12

Art.-No.: 303000

Lightweight elevating tripod made of aluminium for instruments with 5/8" thread.



ELEVATING TRIPOD FS 13

Art.-No.: 304000

Lightweight elevating tripod made of aluminium for instruments with 5/8" thread.



RECEIVER FR 55

Art.-No.: 500510

For line lasers using a red or green laser beam.



RECEIVER FR 75-MM

Art.-No.: 257200

For line lasers using a red or green laser beam.



Multi-functional for versatile levelling jobs at indoor construction sites.

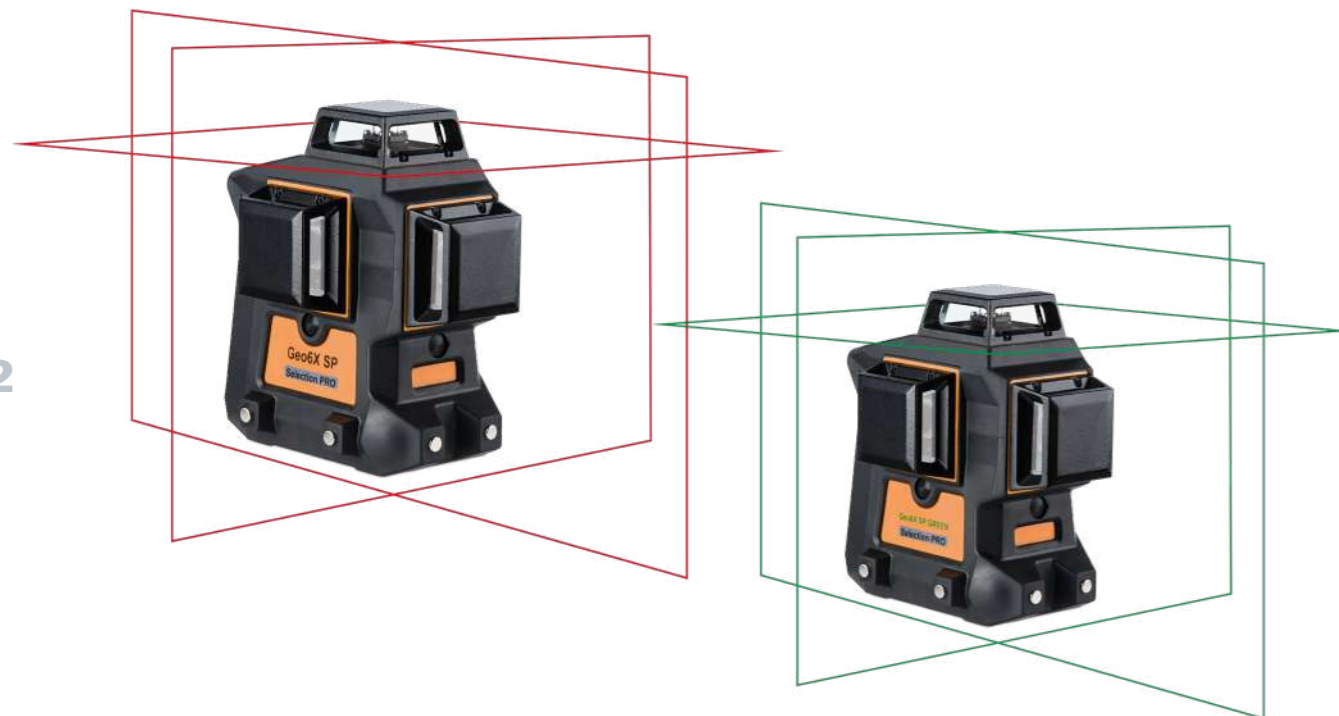

22

GEO6X SP & GEO6X SP GREEN

The Geo6X product family includes 3 models: Geo6X SP, Geo6X SP KIT and Geo6X SP GREEN KIT.

Fully equipped with Li-Ion battery, charger, wall mount and case. These versions offer all the advantages of an innovative tool for the professional user.

DESCRIPTION

- 3 x 360°-laser lines form 6 laser crosses
- Laser lines switchable separately
- Plumbing function
- Laser plane distance to wall / ceiling min. 12 mm
- Magnets at the front and side for connection to dry wall track
- Use with receiver (optional)
- Self-levelling function can be locked for manual use
- 5/8" and 1/4" connection at the instruments bottom

TECHNICAL SPECIFICATIONS

	GEO6X SP	GEO6X SP KIT	GEO6X SP GREEN KIT
Self-levelling range	± 3°	± 3°	± 3°
Accuracy	± 2 mm / 10 m	± 2 mm / 10 m	± 2 mm / 10 m
Working range without receiver	30 m* (radius)	30 m* (radius)	40 m* (radius)
Working range with receiver	60 m ** (radius)	60 m ** (radius)	70 m ** (radius)
Power supply	Alkaline	Alkaline +Li-Ion	Alkaline +Li-Ion

All details at geo-fennel.com

*depending on room brightness
**depending on the alignment of the laser



IP 54



5-16 h

Geo6X SP KIT

Supplied with

Multi-functional mount, Li-Ion battery, charger with USB 3.0 cable, magnetic target, battery case for alkaline batteries, container



Art.-No.: 534100

Geo6X SP GREEN KIT

Supplied with

Multi-functional mount, Li-Ion battery, charger with USB 3.0 cable, magnetic target, battery case for alkaline batteries, container



Art.-No.: 534500

Geo6X SP

Supplied with

4 x alkaline batteries, magnetic target, softbag



Art.-No.: 534000

Suitable Accessoires:



RECEIVER FR 55
Art.-No.: 500510

For line lasers using a red or green laser beam.



RECEIVER FR 75-MM
Art.-No.: 257200

For line lasers using a red or green laser beam.



ADAPTER WS1
Art.-No.: 290560

Adapter for clamp connection at wall track for dropped ceiling installation.



FLOOR-TO-CEILING PILLAR KS 3
Art.-No.: 520100

Floor-to-ceiling pillar (1-leg tripod) to be fixed between floor and ceiling.



ELEVATING TRIPOD FS 12
Art.-No.: 303000

Lightweight elevating tripod made of aluminium for instruments with 5/8" thread.



MOUNT MH 1
Art.-No.: 290555

Multi-functional mount.



For highest requirements, **without compromises.**

**NEW
2022**



FLG 70 GREEN SP

For highest requirements, without compromises. Latest green laser technology with fine and clear line visibility. Quick self-levelling and extremely stable performance. Slope function: laserplane can be tilted in coarse and fine steps by use of remote control.

FLG 70 GREEN SP

Supplied with
Li-Ion batteries, international charger, adapter for in-car charging, compartment for alkaline batteries, remote control, adapter for tripod connection, magnetic target, laser glasses, container



Art.-No.: 582500

Suitable Accessoires:



RECEIVER FR 75-MM

Art.-No.: 257200

For line lasers using a red or green laser beam.



ELEVATING TRIPOD FS 13

Art.-No.: 304000

Lightweight elevating tripod made of aluminium for instruments with 5/8" thread.



ELEVATING TRIPOD FS 50-M

Art.-No.: 164

Column / flat head with 5/8" thread.

24

DESCRIPTION

- 4 vertical lines at 90° to each other
- 360° horizontal line
- Laser cross to the ceiling
- Plumb down beam
- Remote control for setting slopes in coarse and fine steps
- Use with receiver to extend working range
- Self-levelling function can be locked for slope use
- 5/8" thread for use with standard tripod

TECHNICAL SPECIFICATIONS

FLG 70 GREEN SP	
Self-levelling range	± 3°
Accuracy	± 1 mm / 10 m
Working range without receiver	30 m* (radius)
Working range with receiver	80 m (radius)
Power supply	Li-Ion

IP 54 4-8 h

All details at geo-fennel.com

*depending on room brightness



The tiler's best friend - now in green!

26



DESCRIPTION

- High visibility green laser lines
- High visibility laser lines achieved by innovative design
- Independently height adjustable legs for optimum results over the full working range
- Laser lines switchable separately
- Fine motion control for accurate alignment
- Fully rotatable laser head with 360° graduation for optimum flexibility
- Integrated circular bubble for manual levelling on uneven surfaces

TECHNICAL SPECIFICATIONS

GEOSPIDER GREEN	
Accuracy	± 3mm / 10 m
Working range	20 m* (radius)
Power supply	4 x AA alkaline

All details at geo-fennel.com

*depending on room brightness

GEOSPIDER GREEN

The tiler's best friend - now in green!

2 high visibility green laser lines at 90° to each other. Ideal for laying all types of floor coverings such as tiles, laminates, carpets, etc. 360° graduation and fine motion control for accurate alignment. Circular bubble for manual levelling on uneven surfaces.

GeoSpider GREEN

Supplied with
4 x AA alkaline battery, magnetic target, bag



Art.-No.: 552000

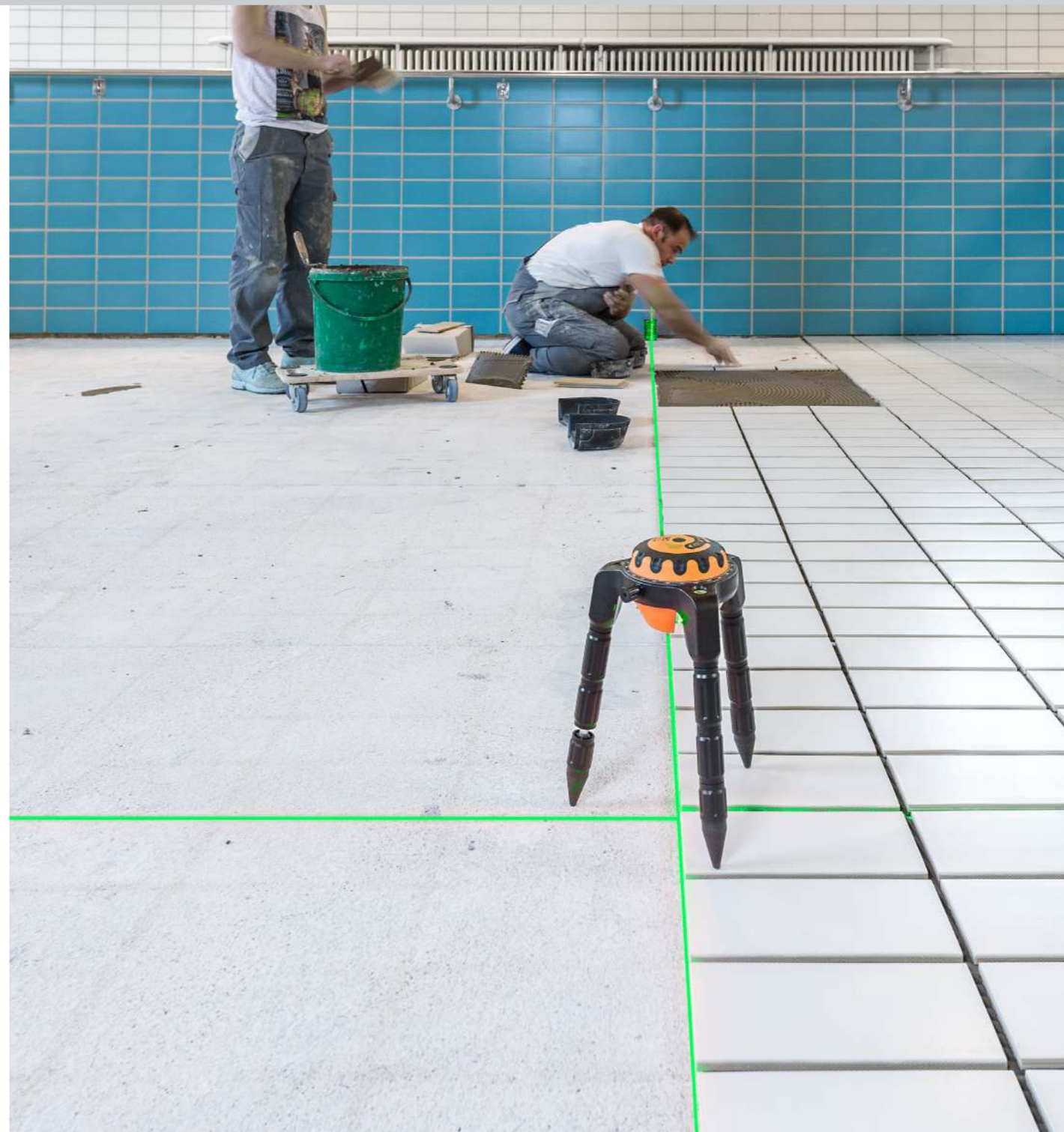

Square Liner II

The angle template generates two laser lines at 90° to each other. Ideal for use on floor and all tiling! 0° to 90° graduation for setting out 90°, 45° or any required angles to floor, wall or ceiling.

Square Liner II

Supplied with
Batteries, magnetic target, case



Art.-No.: 551000

DESCRIPTION

- The laser line can be adjusted continuously vertically or horizontally.
- 0° to 90° graduation for setting out 90°, 45° or any required angles to floor, wall or ceiling
- Magnets
- 1/4" thread for camera tripod

TECHNICAL SPECIFICATIONS

Accuracy	± 3 mm / 10 m
Working range	10 m* (radius)
Power supply	2 x AA alkaline



All details at geo-fennel.com

*depending on room brightness

27

The suitable receivers for your Line Lasers.



28

FR 55-M For the start

Clamp, case

Art.-No.: 500520

Universally applicable for line lasers with red and green laser beam. Height indication by 3 LEDs.

FR 55 The all-rounder

Clamp

Art.-No.: 500510

Universally applicable for line lasers with red and green laser beam. Height indication by 3 LEDs and top and with a large display on the front.

FR 75-MM With digital level indication in millimeters

Clamp

Art.-No.: 257200

For line lasers using a red or green laser beam. Extra long 100 mm receiving window. Mm-indication of difference between laserplane and „0“ level. Segments of display indication increase / decrease proportionally.

EasyTRACK Plus for Line Lasers Optimum alignment - the quick and easy way

EasyTRACK base, EasyTRACK receiver, EasyTRACK remote control, 4 x AA batteries (base), 3 x AA batteries (receiver), 1 x 9V battery (remote control), soft bag

Art.-No.: 290900

DESCRIPTION FR 55-M

- For red and green line lasers
- Height indication by 3 LEDs
- Shut-off tone
- 2-step accuracy
- Automatic shut-off
- Built-in magnet on top

DESCRIPTION FR 55

- For red and green line lasers
- Height indication by 3 LEDs which are situated on the front side and top and with a large display on the front
- Shut-off tone
- Automatic shut-off
- Built-in vials

DESCRIPTION FR 75-MM

- For line lasers using a red or green laser beam
- Extra long receiving window 100 mm
- mm-indication of difference between laserplane and «0» level
- Segments of display indication increase / decrease proportionally
- Illuminated display
- Integrated vials

TECHNICAL SPECIFICATIONS

	FR 55-M	FR 55	FR 75-MM
2-step accuracy	Close distance, far distance	Close distance, far distance	Close distance, far distance
Accuracy mm-indication	-	-	± 1 mm
Power supply	1 x 9V	1 x 9V	4x alkaline

All details at geo-fennel.com



100 h



IP 65



55 h

DESCRIPTION

- 360° horizontal orientation in motorised mode
- Automatic axis alignment of the vertical line with on-level position of receiver (tracking)*
- Alignment of the vertical line to any position with the remote control**
- Manual slow motion screw for axis alignment
- For line lasers with either red or green beam

- Compatible with all geo-FENNEL Line Lasers with pulse function



TECHNICAL SPECIFICATIONS

	EASTRACK FOR LINE LASER
Centring accuracy TRACKING	± 1 mm
Working range	50 m (depending on the laser model used)
Power supply	4x AA alkaline (base), 3 x AA alkaline (receiver)



IP 54



15 h

ROTATING LASERS

Easy to use, accurate,
robust and reliable.

Efficient, flexible and reliable – some of the characteristics that define all geo-FENNEL rotating lasers. Whether used for interior applications or on the most demanding outdoor construction sites, in the rain, wind, cold or hot conditions:

Our robust, water and dust protected laser measuring instruments provide the precise measuring results, even under unfavourable weather conditions.



Rotating Lasers Outline

Simplified product sorting

To make it even easier to find the suitable rotating laser for your application, we have improved our product sorting.

You can now recognise units for the interior or exterior by the markings on the left edge of the page. The units are marked on the left page margin as well as in our overview.

Ideal for indoor use



Ideal for outdoor use



INDOOR USE

	FLG 190A-GREEN	FLG 245HV-GREEN	FLG 245HV-GREEN TRACKING
Laser class	2	2	2
Horizontal levelling	fully automatic	fully automatic	fully automatic
Vertical levelling	manual	fully automatic	fully automatic
Accuracy / 10 m	± 1,5 mm	± 1,0 mm	± 1,0 mm
Dust / water protection	IP 54	IP 54	IP 54
Working range without receiver Ø	40 m	60 m	60 m
Working range with receiver FR 45 Ø	600 m	1000 m	-
Working range with receiver FR 77-MM Ø	-	-	1000 m
rpm	200, 400, 600	300, 800	300, 800
Tracking function	-	-	yes
TILT function	-	yes	yes
VWS function	-	-	-
Slope function of both axis	-	± 5° (9 %)	± 5° (9 %)
Slope setting	-	manual	manual
Plumb up / down beam	yes	yes	yes
Power supply	NiMH	NiMH	NiMH
Receiver, remote control, rechargeable battery, charger	inclusive, without remote	inclusive	inclusive
Page	34	36	38

INDOOR AND OUTDOOR USE

	FL 190A	FL 220HV	FL 245HV+
Laser class	2	2	2
Horizontal levelling	fully automatic	fully automatic	fully automatic
Vertical levelling	manual	fully automatic	fully automatic
Accuracy / 10 m	± 1,5 mm	± 1,0 mm	± 0,75 mm
Dust / water protection	IP 54	IP 54	IP 65
Working range without receiver Ø	30 m	30 m	60 m
Working range with receiver FR 45 Ø	400 m	400 m	1200 m
Working range with receiver FR 77-MM Ø	-	-	600 m
rpm	200, 400, 600	600	300, 800
Tracking function	-	-	-
TILT function	-	yes	yes
VWS function	-	-	-
Slope function of both axis	-	-	± 5° (9 %)
Slope setting	-	-	manual
Plumb up / down beam	yes	yes	100 m
Power supply	NiMH	NiMH	NiMH
Receiver, remote control, rechargeable battery, charger	inclusive, without remote	inclusive, without remote	inclusive
Page	40	42	44

OUTDOOR USE

	FL 105H	FL 115H	FL 155H-G	FL 275HV-TRACKING	FL 300HV-G EASYGRADE	FL 505HV-G	FL 510HV-G TRACKING M
Laser class	2	2	2	2	2	2	2
Horizontal levelling	fully automatic	fully automatic	fully automatic	fully automatic	fully automatic	fully automatic	fully automatic
Vertical levelling	-	-	-	fully automatic	fully automatic	fully automatic	fully automatic
Accuracy / 10 m	± 1,0 mm	± 0,5 mm	± 0,5 mm	± 0,5 mm	± 0,75 mm	± 0,5 mm	± 0,5 mm
Dust / water protection	IP 65	IP 66	IP 65	IP 66	IP 66	IP 66	IP 66
Working range without receiver Ø	40 m	60 m	-	40 m	-	40 m	40 m
Working range with receiver FR 45 Ø	600 m	1200 m	1200 m	-	1200 m	-	-
Working range with receiver FR 77-MM Ø	300 m	900 m	600 m	400 m	600 m	400 m	400 m
rpm	800	800	500, 800	300, 800	800	300,600,1100	300,600,1100
Tracking function	-	-	-	yes	-	-	yes
TILT function	yes	yes	yes	yes	yes	yes	yes
VWS function	yes	yes	yes	yes	yes	yes	yes
Slope function of both axis	-	± 5° (9 %)	± 6° (10 %)	± 5° (9 %)	+ 6.9 % (X)	± 10 %	± 10 %
Slope setting	-	manual	digital / controlled	manual	numeric / controlled	digital / controlled	digital / controlled
Plumb up / down beam	-	-	-	yes	yes	yes	yes
Power supply	NiMH	Li-Ion	Li-Ion	Li-Ion	Li-Ion	Li-Ion	Li-Ion
Receiver, remote control, rechargeable battery, charger	inclusive, without remote	inclusive	inclusive	inclusive	inclusive	inclusive	inclusive
Page	46	48	50	52	54	56	58

Instant self-levelling – outstanding laser line visibility



FLG 190A-GREEN

Perfect for indoor applications with outstanding laser line visibility due to PowerSwitch-Technology.

Incorporating a green beam laser diode for improved visibility under difficult light conditions. Ideal for use in bright surroundings, over long distances and against dark measuring surfaces.

Self-levelling in a matter of seconds makes this laser ideal for applications where the unit has to be moved frequently, e.g. in screed construction.

DESCRIPTION

- Instant self-levelling
- Horizontal fully automatic self-levelling rotating laser
- Vertical levelling using adjustment screw
- Variable rotating speed
- Permanent 90° beam to zenith
- Rechargeable NiMH batteries with intelligent charger
- Integrated floor / wall mount with adjustment screw

TECHNICAL SPECIFICATIONS

Self-levelling range	± 3°
Accuracy	± 1,5 mm / 10 m
Laser diode / Laser class	green / 2
Working range without receiver	40 m* Ø
Working range with receiver	600 m Ø

All details at geo-fennel.com

*depending on room brightness



IP 54



12 h



Green laser



200 - 600 rpm

FLG 190A-GREEN with FR 45

Supplied with

Receiver FR 45 with clamp for levelling staff, NiMH batteries, charger, carrying case



Art.-No.: 292195

FLG 190A-GREEN with FR-DIST 30

Supplied with

Receiver FR-DIST 30 with clamp for levelling staff, NiMH batteries, charger, carrying case



Art.-No.: 292198

Suitable Accessoires:



LEVELLING STAFF TN 15-0

Art.-No.: 486

A high quality levelling staff made of strong aluminium tubes available in 5 m.



ALUMINIUM TRIPODS FS 20

Art.-No.: 151

For light measuring instruments such as automatic levels. Flat head tripod.



ELEVATING TRIPOD FS 12/13

Art.-No.: 303000, 304000

Lightweight elevating tripods made of aluminium for instruments with 5/8" thread.



A professional multipurpose laser for indoor applications.



FLG 245HV-GREEN

Perfect for indoor applications with excellent visibility of the laser line due to PowerSwitch-Technology.

The green laser diode increases the visibility of the laser line under difficult working conditions such as bright environments, long distances, dark measuring surfaces.

Versatile with rotating, scanning and point functions.

FLG 245HV-GREEN with FR 45

Supplied with

Receiver FR 45 with clamp, remote control, rechargeable battery (NiMH), intelligent charger, battery case for alkaline batteries, adjustable wall and ceiling mount, laser glasses, magnetic target, container



Art.-No.: 244501

FLG 245HV-GREEN with FR-DIST 30

Supplied with

Receiver FR-DIST 30 with clamp, remote control, rechargeable battery (NiMH), intelligent charger, battery case for alkaline batteries, adjustable wall and ceiling mount, laser glasses, magnetic target, container



Art.-No.: 244531

Suitable Accessoires:

LEVELLING STAFF TN 15-0

Art.-No.: 486

A high quality levelling staff made of strong aluminium tubes available in 5 m.

LEVELLING STAFF TN 20-K

Art.-No.: 482

Levelling staff for reading height differences. Length 2.40 m.

ELEVATING TRIPOD FS 30-M/L

Art.-No.: 158, 156

Column / flat head. Continuous opening for instruments with plumb down beam.



DESCRIPTION

- Working range up to 1000 m in diameter
- Variable scanning and laser point mode
- Permanent 90° plumb beam
- Auto-shut-off when out of level
- Manual slope setting of X and Y axis
- Remote control function (on/off)

TECHNICAL SPECIFICATIONS

Self-levelling range	± 5°
Accuracy	1,0 mm / 10 m horizontal, 1,5 mm / 10 m vertical
Working range without receiver	60 m* Ø, 40 m Ø (rotating w/o receiver)
Working range with receiver	1000 m Ø
Power supply	NiMH

All details at geo-fennel.com

*depending on room brightness



IP 54



Green laser (LC 2)



PowerSwitch - Technology



24 h



300, 800 rpm



Automatic TILT function

The ultimate solution for easy axis alignment combined with **perfect laser line visibility**.



FLG 245HV-GREEN TRACKING

TRACKING function: The rotating plane automatically aligns to the zero position of the receiver, making long-distance alignment a breeze.

User-friendly operating concept: main functions on the unit, additional functions on the remote control, TRACKING function with the receiver.

Excellent visibility even without receiver, with versatile scanning and point functions.

FLG 245HV-GREEN TRACKING with FR-77 MM Tracking

Supplied with

Receiver FR 77-MM Tracking with clamp for levelling staff, remote control, rechargeable batteries, charger, battery case for alkaline batteries, wall mount, floor mount, magnetic target, laser glasses, carrying case



Art.-No.: 244701

Suitable Accessoires:

LEVELLING STAFF TN 15-0

Art.-No.: 486

A high quality levelling staff made of strong aluminium tubes available in 5 m.

LEVELLING STAFF TN 20-K

Art.-No.: 482

Levelling staff for reading height differences. Length 2.40 m.

ELEVATING TRIPOD FS 30-M/L

Art.-No.: 158, 156

Column / flat head. Continuous opening for instruments with plumb down beam.

DESCRIPTION

- Working range up to 1000 m in diameter
- Dust / water protection IP 54
- Variable scanning and laser point mode
- Permanent 90° plumb beam
- Automatic TILT alarm function
- Auto-shut-off when out of level
- Manual slope setting of X and Y axis
- Remote control function (on/off)
- Floor mount with centring mark for accurate set up over a ground point

TECHNICAL SPECIFICATIONS

Self-levelling range	± 5°
Accuracy	1,0 mm / 10 m horizontal, 1,5 mm / 10 m vertical
Laser diode / laser class	green / 2
Working range without receiver	60 m* Ø, 40 m Ø (rotating w/o receiver)
Working range with receiver	1000 m Ø
Power supply	NIMH



IP 54



Green laser (LC 2)



Tracking laser



24 h



300, 800 rpm



Automatic TILT function

All details at geo-fennel.com

*depending on room brightness



The all-rounders in the entry-level range - unique fast self-levelling.



FL 190A

Rotating laser FL 190A is ideally suited for excavation and transferring levels. Whether you are screeding, excavation or aligning a wall, ... the instant self-levelling and extended range ensure fast and precise results.

FL 190A with FR 45

Supplied with
Receiver FR 45 with clamp for levelling staff, NiMH batteries, charger, carrying case



Art.-No.: 292190

FL 190A with FR-DIST 30

Supplied with
Receiver FR-DIST 30 with clamp for levelling staff, NiMH batteries, charger, carrying case



Art.-No.: 292193

FL 190A SET

Supplied with
NiMH batteries, charger, receiver FR 45 with clamp, 5 m levelling staff, aluminium tripod, case



Art.-No.: 292190-BC

Suitable Accessoires:

LEVELLING STAFF TN 15-0

Art.-No.: 486

A high quality levelling staff made of strong aluminium tubes available in 5 m.

LEVELLING STAFF TN 20-K

Art.-No.: 482

Levelling staff for reading the height differences. Length 2.40 m.

ELEVATING TRIPOD FS 12/13

Art.-No.: 303000, 304000

Lightweight elevating tripods made of aluminium for instruments with 5/8" thread.

DESCRIPTION

- Instant self-levelling
- Horizontal self-levelling rotating laser; vertical levelling with one footscrew
- Automatic shut-off and audible alarm when out of self-levelling range
- Variable rotating speed
- Permanent 90° beam to zenith
- Rechargeable NiMH batteries with intelligent charger
- Integrated floor / wall mount with adjustment screw

TECHNICAL SPECIFICATIONS

Self-levelling range	± 3°
Accuracy	± 1,5 mm / 10 m
Laser diode / laser class	red / 2
Working range without receiver	30 m* Ø
Working range with receiver	400 m Ø

All details at geo-fennel.com

*depending on room brightness



IP 54



20 h



Red laser (LC 2)



200, 400, 600 rpm

Straight to the point - **without frills.**



FL 220HV

Fully automatic self-levelling horizontal and vertical laser.
A multipurpose rotating laser for indoor and outdoor applications.
3 buttons for user-friendly functionality.

DESCRIPTION

- Working range up to 400 m in diameter
- Permanent 90° plumb beam
- Auto-shut-off when out of level
- Manual mode

TECHNICAL SPECIFICATIONS

Self-levelling range	± 5°
Accuracy	± 1 mm / 10 m horizontal, ± 1,5 mm / 10 m vertical
Working range without receiver	30 m* Ø
Working range with receiver	400 m Ø

All details at geo-fennel.com

*depending on room brightness



IP 54



20 h



Red laser (LC 2)



600 rpm



Automatic TILT function

FL 220HV with FR 45

Supplied with Receiver FR 45 with clamp, rechargeable battery (NiMH), intelligent battery charger, battery case for alkaline batteries, carrying case



Art.-No.: 220000

FL 220HV SET

Supplied with Receiver FR 45 with clamp, rechargeable battery (NiMH), intelligent battery charger, battery case for alkaline batteries, 5 m levelling staff, aluminium tripod, carrying case



Art.-No.: 220000-BC

Suitable Accessoires:



LEVELLING STAFF TN 15-0

Art.-No.: 486

A high quality levelling staff made of strong aluminium tubes available in 5 m.



LEVELLING STAFF TN 20-K

Art.-No.: 482

Levelling staff for reading the height differences. Length 2.40 m.



ELEVATING TRIPOD FS 12/13

Art.-No.: 303000, 304000

Lightweight elevating tripods made of aluminium for instruments with 5/8" thread.



A professional multipurpose laser for indoor and outdoor applications.



FL 245HV+

Long range outside and best visibility inside with PowerSwitch-Technology: the power of a class 3R laser in a class 2 laser.

All additional functions including scanning and slope setting are accessed from the remote control.

DESCRIPTION

- Working range up to 1200 m in diameter (depending on receiver)
- Dust / water protection IP 65
- Variable scanning and laser point mode
- Permanent 90° plumb beam
- Automatic TILT alarm function
- Auto-shut-off when out of level
- Manual slope setting of X and Y axis
- Remote control function (on/off)

TECHNICAL SPECIFICATIONS

Self-levelling range	± 5°
Accuracy horizontal	± 0,75 mm / 10 m
Accuracy vertical	± 1 mm / 10 m
Working range without receiver	60 m* Ø
Working range with receiver	1200 m (FR 45), 600 m (FR-DIST 30 and FR 77-MM)

All details at geo-fennel.com

*depending on room brightness



IP 65



Red laser (LC 2)



PowerSwitch - Technology



26 h



300, 800 rpm



Automatic TILT function

FL 245HV+ with FR 45

Supplied with Receiver FR 45 with clamp, remote control, rechargeable battery (NiMH), intelligent battery charger, wall mount, floor mount, battery case for alkaline batteries, laser glasses, magnetic target, carrying case

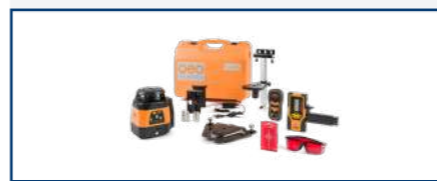

Art.-No.: 244045

FL 245HV+ with FR-DIST 30

Supplied with Receiver FR-DIST 30 with clamp, remote control, rechargeable battery (NiMH), intelligent battery charger, wall mount, floor mount, battery case for alkaline batteries, laser glasses, magnetic target, carrying case



Art.-No.: 244050

FL 245HV+ with FR 77-MM

Supplied with Receiver FR 77-MM with clamp, remote control, rechargeable battery (NiMH), intelligent battery charger, wall mount, floor mount, battery case for alkaline batteries, laser glasses, magnetic target, carrying case



Art.-No.: 244077

Suitable Accessoires:



WALL MOUNT WH 3
Art.-No.: 290605

Robust mounting for attaching of rotating and line lasers on the wall or on ceiling profiles.



SCAFFOLD CLAMP HOLDER SH 2
Art.-No.: 320610

For quick centring over the linchpin.



LEVELLING STAFF TN 15-0
Art.-No.: 486

A high quality levelling staff made of strong aluminium tubes available in 5 m.



LEVELLING STAFF TN 20-K
Art.-No.: 482

Levelling staff for reading the height differences. Length 2.40 m.



ALUMINIUM TRIPODS FS 20
Art.-No.: 151

For light measuring instruments such as automatic levels. Quick clamp system.



ELEVATING TRIPOD FS 30-M/L
Art.-No.: 158,156

Column / Flat head. Continuous opening for instruments with plumb down beam.



The latest generation of construction laser for horizontal applications.



FL 105H

New innovative low friction drive mechanism and self-levelling module. Accurate, robust and temperature stable. Low friction drive for reduced noise emission. Increased battery life.

DESCRIPTION

- Self-levelling horizontal rotating laser
- 3 buttons for user-friendly functionality
- Working range 600 m in diameter
- Auto-shut-off when out of level

TECHNICAL SPECIFICATIONS

Self-levelling range	± 5°
Accuracy horizontal	± 1,0 mm / 10 m
Working range with receiver	600 m (FR 45), 300 m (FR 77-MM)

All details at geo-fennel.com



IP 65



Red laser



Horizontal



VWS function



36 h



800 rpm



Automatic TILT function

FL 105H with FR 45

Supplied with Receiver FR 45 with clamp for levelling staff, rechargeable battery and charger, battery compartment for alkaline batteries, container

BASIC PACKAGE



Art.-No.: 212001

IN SET



Art.-No.: 212001-S02

FL 105H with FR 77-MM

Supplied with Receiver FR 77-MM with clamp for levelling staff, rechargeable battery and charger, battery compartment for alkaline batteries, container

BASIC PACKAGE



Art.-No.: 212078

IN SET



Art.-No.: 212078-S01

FL 105H with FR-DIST 30

Supplied with Receiver FR-DIST 30 with clamp for levelling staff, rechargeable battery and charger, battery compartment for alkaline batteries, container



Art.-No.: 212031

Suitable Accessoires:



LEVELLING STAFF TN 15-0
Art.-No.: 486

A high quality levelling staff made of strong aluminium tubes available in 5 m.



LEVELLING STAFF TN 20-K
Art.-No.: 482

Levelling staff for reading the height differences. Length 2.40 m.



ALUMINIUM TRIPODS FS 20
Art.-No.: 151

For light measuring instruments such as automatic levels. Quick clamp system.



ELEVATING TRIPOD FS 30-M/L
Art.-No.: 158, 156

Column / flat head. Continuous opening for instruments with plumb down beam.



FMR 700-M/C
Art.-No.: 260550

A machine control receiver to improve the operating accuracy of your construction machinery.



Premium horizontal laser



FL 115H

The latest generation premium laser for horizontal applications.

- New innovative low friction drive mechanism and self-levelling module
- Accurate, robust and temperature stable
- Low friction drive for reduced noise emission

Improved performance:

- Extra long working range
- Rotating speed 800 rpm for optimal usage with machine control receivers

FL 115H with FR 45

Supplied with Receiver FR 45 with clamp, Li-Ion rechargeable battery with charger, battery case for alkaline batteries, container

BASIC PACKAGE



Art.-No.: 211001

IN SET



Art.-No.: 211001-S02

FL 115H with FR 77-MM

Supplied with Receiver FR 77-MM with clamp, Li-Ion rechargeable battery with charger, battery case for alkaline batteries, container

BASIC PACKAGE



Art.-No.: 211078

IN SET



Art.-No.: 211078-S01

FL 115H with FR-DIST 30

Supplied with FR-DIST 30 with clamp, Li-Ion rechargeable battery with charger, battery case for alkaline batteries, container



Art.-No.: 211031

Suitable Accessoires:



LEVELLING STAFF TN 15-0

Art.-No.: 486

A high quality levelling staff made of strong aluminium tubes available in 5 m.



LEVELLING STAFF TN 20-K

Art.-No.: 482

Levelling staff for reading the height differences. Length 2.40 m.



ELEVATING TRIPOD FS 50 M/L

Art.-No.: 164, 166

Extremely stable construction, e.g. for the safe use of rotating lasers in adverse weather conditions.



ELEVATING TRIPOD FS 30-M/L

Art.-No.: 158, 156

Column / flat head. Continuous opening for instruments with plumb down beam.



FMR 700-M/C

Art.-No.: 260550

A machine control receiver to improve the operating accuracy of your construction beam.

48

DESCRIPTION

- Easy and intuitive to use
- Robust rubberised housing with metal cover
- Self-levelling premium horizontal laser
- Automatic TILT alarm function
- VWS function (Vibration-Wind-Security)
- Auto-shut-off when out of level
- Electronic beam screen
- Manual slope setting of X and Y axis
- Li-Ion battery technology

TECHNICAL SPECIFICATIONS

Self-levelling range	± 5°
Accuracy horizontal	± 0,5 mm / 10 m
Working range with receiver	1200 m (FR 45), 900 m (FR 77-MM / FMR 706)
Manuelle slope setting	±5° (±9%)

All details at geo-fennel.com



IP 66



Red laser (LC 2)



Horizontal



VWS function



26 h



800 rpm



Automatic TILT function

Dual grade laser for outdoor application - Power Switch-Technology and long range.



FL 155H-G

Further development of the FL 155H-G

- PowerSwitch-Technology: the power of a class 3R laser in a class 2 laser for a large range
- Robust rubberised housing for on-site protection
- Zonal control (electronic beam screen) eliminates interference from other lasers

Easy operation

- Digital setting of grade values
- Monitored grade
- Reduced number of buttons for ease-of-use

DESCRIPTION

- Horizontal dual grade laser
- Digital grade adjustment
- Monitored grade
- Illuminated display
- Zonal control (masking)
- Remote control screen
- Li-Ion battery technology
- Battery charger includes adapter for in-car charging

TECHNICAL SPECIFICATIONS

Self-levelling range	± 6°
Accuracy	± 0,5 mm / 10 m
Working range with receiver FR 45	1200 m Ø
Working range with receiver FR 77-MM	600 m Ø
Horizontal slope setting	± 10.000% (X and Y-Axis)

All details at geo-fennel.com



IP 65



Red laser (LC 2)



Horizontal



VWS function



30 h



500, 800 rpm



Automatic TILT function

Suitable Accessoires:



LEVELLING STAFF TN 15-0
Art.-No.: 486

A high quality levelling staff made of strong aluminium tubes available in 5 m.



LEVELLING STAFF TN 20-K
Art.-No.: 482

Levelling staff for reading the height differences. Length 2.40 m.



ALUMINIUM TRIPODS FS 20
Art.-No.: 151

For light measuring instruments such as automatic levels. Quick clamp system.



ELEVATING TRIPOD FS 50 M/L
Art.-No.: 164, 166

Extremely stable construction, e.g. for the safe use of rotating lasers in adverse weather conditions.



ELEVATING TRIPOD FS 30-M/L
Art.-No.: 158, 156

Column / flat head. Continuous opening for instruments with plumb down beam.



FMR 700-M/C
Art.-No.: 260550

A machine control receiver to improve the operating accuracy of your construction machinery.

FL 155H-G with FR 45

Supplied with Receiver FR 45 with clamp, 2-way RF remote control, Li-Ion battery, intelligent battery charger, battery case for alkaline batteries, carrying case



Art.-No.: 213145

FL 155H-G with FR 77-MM

Supplied with FR 77-MM with clamp, 2-way RF remote control, Li-Ion battery, intelligent battery charger, battery case for alkaline batteries, carrying case



Art.-No.: 213177

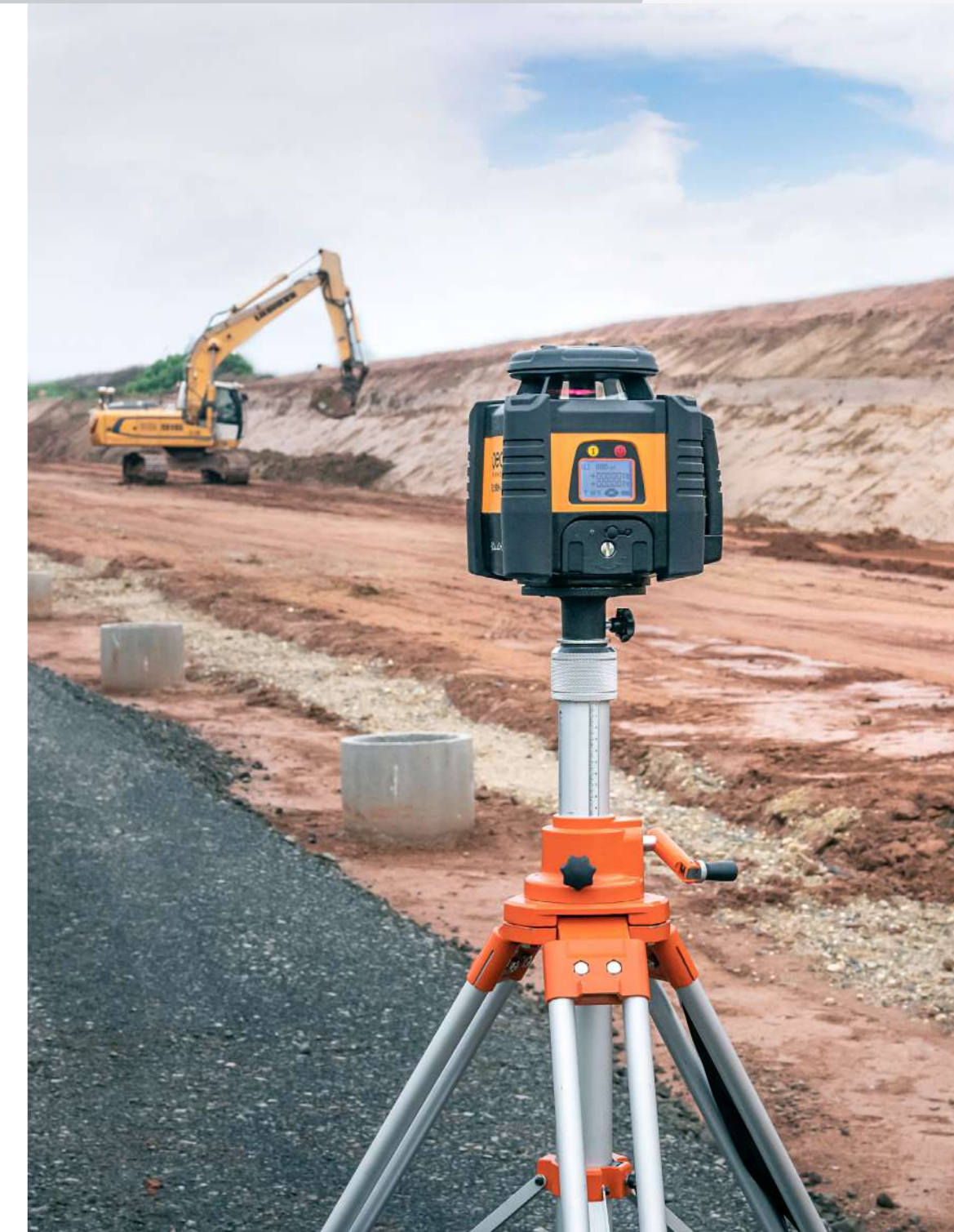

The all-rounder for outdoor use.



FL 275HV-TRACKING

Horizontal and vertical TRACKING function for automatic axis alignment. Axis alignment for high-rise construction, scaffolding, ramp, landscape gardening

TRACKING function: The rotation plane automatically aligns to the receiver's zero position - makes long-distance alignment a breeze.

mm-indicating receiver FR 77-MM TRACKING – the visible accuracy.

FL 275HV-TRACKING with FR 77-MM TRACKING

Supplied with Receiver FR 77-MM TRACKING with clamp for levelling staff, remote control, rechargeable batteries, charger, battery case for alkaline batteries, floor mount, magnetic target, laser glasses, carrying case



Art.-No.: 242701

Suitable Accessoires:



WALL MOUNT WH 2
Art.-No.: 290610

Robust mount for attaching, rotating and line lasers on wall or on ceiling profiles.



SCAFFOLD CLAMP HOLDER SH 2
Art.-No.: 320610

For quick centring over the linchpin.



LEVELLING STAFF TN 15-0
Art.-No.: 486

A high quality levelling staff made of strong aluminium tubes available in 5 m.



LEVELLING STAFF TN 20-K
Art.-No.: 482

Levelling staff for reading the height differences. Length 2.40 m.



ELEVATING TRIPOD FS 50 M/L
Art.-No.: 164, 166

Extremely stable construction, e.g. for the safe use of rotating lasers in adverse weather conditions.



ELEVATING TRIPOD FS 30-M/L
Art.-No.: 158, 156

Column / flat head. Continuous opening for instruments with plumb down beam.

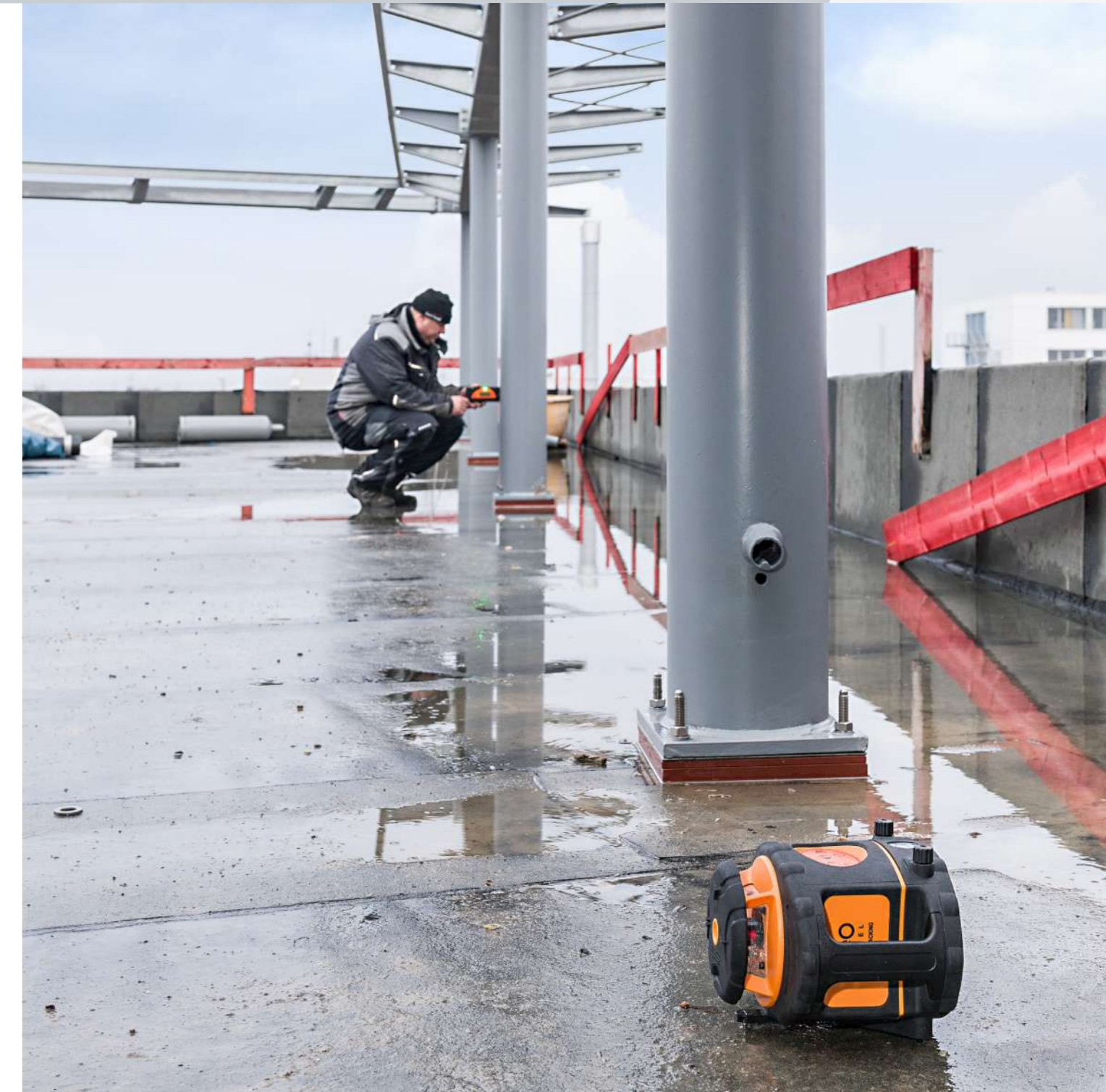

DESCRIPTION

- TRACKING function for automatic axis alignment horizontal and vertical
- The laser plane is automatically centred to the receiver «on-grade»
- Easy one-button operation of TRACKING function
- Working range of TRACKING function 70 m
- mm-indicating receiver FR 77-MM TRACKING
- Vertical: in both X and Y axis
- Horizontal: one axis X or Y, opposite axis self-levelled
- Enhanced scanning functions with small increments and a range up to 180°

- Permanent 90° beam for right angles
- Auto-shut-off when out of level
- Remote control function on/off: to avoid interference with other remote controls or mobile devices
- Manual slope setting of X and Y axis or auto self-level of opposite axis
- Floor mount with centring mark for accurate set up above a ground point
- Li-Ion battery technology

TECHNICAL SPECIFICATIONS

Self-levelling range	± 5°
Accuracy horizontal	± 0,5 mm / 10 m
Accuracy vertical	± 1 mm / 10 m
Working range without receiver	400 m*
Working range with receiver	400 m (FR 77-MM Tracking)

IP 66 Red laser (LC 2) 300, 800 rpm

VWS function Automatic TILT function

All details at geo-fennel.com

*depending on room brightness

The easiest grade laser.



54

DESCRIPTION

- Horizontal
- Self-levelling
- Numerical grade setting in X-Axis
- Manual grade setting in Y-Axis with remote controle
- Vertical
- Self-levelling
- Axis direction in Y-Axis with remote control

TECHNICAL SPECIFICATIONS

Self-levelling range	± 5°
Accuracy horizontal	± 0,75 mm / 10 m
Accuracy vertical	± 1 mm / 10 m
Working range with receiver	1200 m (FR 45), 600 m (FR-DIST 30, FR 77-MM)

All details at geo-fennel.com

FL 300HV-G EasyGRADE

Many users find dual-axis grade lasers too complicated, expensive or overloaded with features.

The FL 300HV-G EasyGRADE brings a new meaning to user friendly and ease-of-use! Simply press the „%“ buttons on the keypad to set the desired grade of X-axis - it's as easy as that.

Ideal for setting-out gradients for surface drainage, paving, landscaping etc. The range from 0.1% to 6.9% covers the majority of on-site tasks.

PowerSwitch-Technology: the power of a class 3R laser in a class 2 laser. IP 66, high accuracy, robustness, Li-Ion battery.

- IP 66
- Red laser (LC 2)
- Horizontal
- VWS function
- 40 h
- 800 rpm
- Vertical
- Automatic TILT function

FL 300HV-G EasyGRADE with FR 45

Supplied with Receiver FR 45 with clamp, remote control, rechargeable battery (Li-Ion), intelligent battery charger, battery case for alkaline batteries, floor / wall mount (integrated), carrying case



Art.-No.: 214045

FL 300HV-G EasyGRADE with FR 77-MM

Supplied with Receiver FR 77-MM with clamp, remote control, rechargeable battery (Li-Ion), intelligent battery charger, battery case for alkaline batteries, floor / wall mount (integrated), carrying case



Art.-No.: 214077

FL 300HV-G EasyGRADE with FR-DIST 30

Supplied with Receiver FR-DIST 30 with clamp, remote control, rechargeable battery (Li-Ion), intelligent battery charger, battery case for alkaline batteries, floor / wall mount (integrated), carrying case



Art.-No.: 214050

Suitable Accessoires:

LEVELLING STAFF TN 15-0
Art.-No.: 486

A high quality levelling staff made of strong aluminium tubes available in 5 m.

LEVELLING STAFF TN 20-K
Art.-No.: 482

Levelling staff for reading the height differences. Length 2.40 m.

ALUMINIUM TRIPODS FS 20
Art.-No.: 151

For light measuring instruments such as automatic levels. Quick clamp system.

ELEVATING TRIPOD FS 50 M/L
Art.-No.: 164, 166

Extremely stable construction, e.g. for the safe use of rotating lasers in adverse weather conditions.

ELEVATING TRIPOD FS 30-M/L
Art.-No.: 158, 156

Column / flat head. Continuous opening for instruments with plumb down beam.

FMR 700-M/C
Art.-No.: 260550

A machine control receiver to improve the operating accuracy of your construction machinery.



The professional dual grade laser.



FL 505HV-G

Improved performance through **PowerSwitch-Technology**:
The power of a class 3R in a class 2 laser.

4 mm laser beam diameter for optimised compatibility with our
FMR 700/800 over long distances.

Now with receiver FR 77-MM with mm-indication as standard.

- Fully automatic self-levelling in horizontal, vertical and grade
- Slope functions horizontal: digital grade setting of X and Y axis up to $\pm 10\%$
- Manual slope setting of X and Y axis
- Slope functions vertical: direction of X axis can be set up to $\pm 10\%$ with Y axis self-levelled direction of X and Z axis can be set manually
- Li-Ion battery technology

DESCRIPTION

- Dual grade laser
- Horizontal and vertical
- Digital grade setting
- Monitored grade
- TILT function
- VWS function
- 90° beam to zenith
- Illuminated display
- 2 way RF remote control
- Manual function
- 4-step scanning function
- Operation with rechargeable Li-Ion or alkaline batteries

TECHNICAL SPECIFICATIONS

Self-levelling range	$\pm 8^\circ$
Accuracy horizontal	$\pm 0,5 \text{ mm} / 10 \text{ m}$
Accuracy vertical	$\pm 1 \text{ mm} / 10 \text{ m}$
Working range remote control	150 m
Working range without receiver	60 m * Ø
Working range with receiver	400 m Ø

All details at geo-fennel.com

*depending on room brightness



IP 66



Red laser (LC 2)



Horizontal



VWS function



40 h



300, 600, 1100 rpm



Vertical



Automatic TILT function

Suitable Accessoires:



LEVELLING STAFF TN 15-0
Art.-No.: 486

A high quality levelling staff made of strong aluminium tubes available in 5 m.



LEVELLING STAFF TN 20-K
Art.-No.: 482

Levelling staff for reading the height differences. Length 2.40 m.



ALUMINIUM TRIPODS FS 20
Art.-No.: 151

For light measuring instruments such as automatic levels. Quick clamp system.



ELEVATING TRIPOD FS 50 M/L
Art.-No.: 164, 166

Extremely stable construction, e.g. for the safe use of rotating lasers in adverse weather conditions.



ELEVATING TRIPOD FS 30-M/L
Art.-No.: 158, 156

Column / flat head. Continuous opening for instruments with plumb down beam.



FMR 700-M/C
Art.-No.: 260550

A machine control receiver to improve the operating accuracy of your construction machinery.

FL 505HV-G with FR 77-MM

Supplied with Receiver FR 77-MM with clamp, 2-way RF remote control, Li-Ion battery & charger, vertical mount, telescope, alkaline battery case, container



Art.-No.: 231025

FL 505HV-G with FR-DIST 30

Supplied with Receiver FR-DIST 30 clamp, 2-way RF remote control, Li-Ion battery & charger, vertical mount, telescope, alkaline battery case, container



Art.-No.: 231055

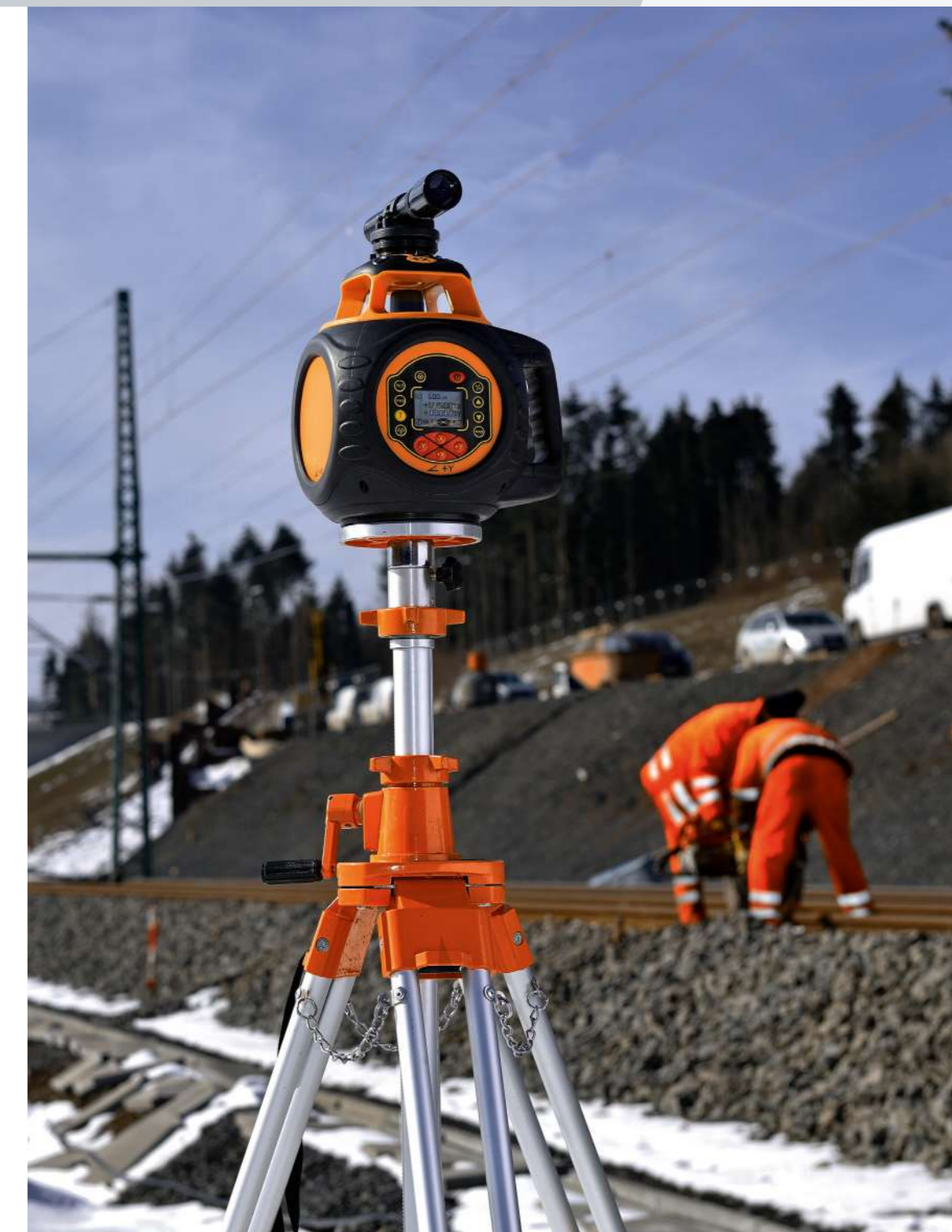

The ideal outdoor laser.



58

DESCRIPTION

- Dual grade laser
- Horizontal and vertical
- Digital grade setting
- Monitored grade (also in tracking mode)
- TILT function
- VWS function
- Tracking function horizontal and vertical
- Zonal control
- 90° beam to zenith
- Illuminated display
- 2-way RF remote control
- Manual function
- Operation with rechargeable Li-Ion or alkaline batteries

TECHNICAL SPECIFICATIONS

Self-levelling range	± 8°
Accuracy horizontal	± 0,5 mm / 10 m
Accuracy vertical	± 1 mm / 10 m
Working range remote control	100 m
Working range tracking function	140 m*
Working range with receiver FR 77-MM Tracking	400 m Ø

All details at geo-fennel.com

*depending on room brightness



IP 66



Red Laser (LC 2)



horizontal



40 h



300, 600, 1100 rpm



vertical

FL 510HV-G TRACKING M

4 mm laser beam diameter for optimized compatibility at use with FMR 700 / 800 at long distance.

Tracking functions:

The laser plane is automatically centred to the receiver "on-grade."

Vertical: in both X and Y axis

Horizontal: one axis X or Y, other axis horizontal self-levelled.

For highest demands:

Exact monitoring of the tracked axis by continuous radio link between rotating laser and receiver. This application requires the use of a 2nd receiver for height checking work. Indication of grade value in % after completion of tracking process shown on the instrument and remote control display.

Slope functions:

Horizontal:

Digital grade setting of X and Y axis up to ±10 %.
Manual slope setting of X and Y axis.

Vertical:

Direction of X axis can be set up to ±10 % with Y axis self-levelled. Direction of X and Z axis can be set manually.

Last tracked or keyed in grade value is retained after switching off and is retrievable from the memory (both X and Y axis).



FL 510HV-G TRACKING M with FR 77-MM TRACKING

Supplied with Receiver FR 77-MM Tracking with clamps for levelling staff and scaffold, rechargeable batteries and charger, 2-way RF remote control, Li-Ion batteries and charger, vertical mount, telescopic viewfinder, container



Art.-No.: 231700

Suitable Accessoires:



SCAFFOLD CLAMP HOLDER SH 2
Art.-No.: 320610

For quick centring over the linchpin.



LEVELLING STAFF TN 20-K
Art.-No.: 482

Levelling staff for reading the height differences. Length 2.40 m.



ADAPTER FCA-L FOR LASERS
Art.-No.: 290820

Adapter to facilitate facade construction and monitoring with rotating lasers.



ADAPTER FCA-E FOR RECEIVERS
Art.-No.: 290830

Adapter to facilitate facade construction and monitoring with rotating lasers.



ELEVATING TRIPOD FS 50 M/L
Art.-No.: 164, 166

Extremely stable construction, e.g. for the safe use of rotating lasers in adverse weather conditions.



ELEVATING TRIPOD FS 30-M/L
Art.-No.: 158, 156

Column / flat head. Continuous opening for instruments with plumb down beam.



FMR 800-M/C
Art.-No.: 264500

Machine control receiver used with construction machinery for permanent height control.



The suitable receiver for your Rotating Laser



FR DIST 30 with integrated laser distance meter

Clamp for levelling staff, 4 x AA alkaline batteries

Art.-No.: 257300

Innovation:

- AUTO-DIST function measures the distance between laser plane («0» level of receiver) and floor, wall, object automatically

Applications:

- Makes the levelling staff unnecessary for height control works with a rotating laser
- Quick and contact-free height control
- Easy checking of ditch depth when working with an excavator



FR 45 receiver for rotating lasers

Clamp for levelling staff

Art.-No.: 252000



FR 77-MM with digital level indication in millimeters.

4 x AA alkaline, clamp for levelling staff, bracket

Art.-No.: 257100



FR 77-MM TRACKING receiver for FLG 245, FL 275, FL 510 (previous model)

4 x AA alkaline, clamp for levelling staff, bracket

Art.-No.: 257150

FR 77-MM TRACKING M receiver for FL 510HV-G TRACKING M

4 x AA alkaline, clamp for levelling staff, bracket

Art.-No.: 257150-M



NEW
2022

Metal Clamp for all FR 77-MM laser receivers as well as FR-DIST 30, FR 75-MM

FR 77-MM and FR 77-MM TRACKING are standardly supplied with metal clamp

Art.-No.: 257505

TECHNICAL SPECIFICATIONS

	FR-DIST 30	FR 45
Accuracy, 3-step	1 mm / 5 mm / 9 mm	10 mm, 4 mm, 2 mm
Display illumination	yes	yes
Dust / water protection	IP 65	IP 66
Accuracy	± 2 mm	± 10 mm, ± 4 mm, ± 2 mm
Measuring range	50 m	-

DESCRIPTION FR-DIST 30

- Can be used with either red or green beam rotating lasers
- mm-indication of difference between laserplane and «0» level
- Extensive laser distance meter functions

DESCRIPTION FR 45

- For lasers with red or green laser beam
- Height indication by 3 LEDs
- With clamp
- Shut-off tone
- Automatic shut-off
- Built-in vials

DESCRIPTION FR 77-MM + FR 77-MM TRACKING (M)

- For rotating lasers using a red and green laser beam
- Extra-long receiving window
- mm-indication of difference between laserplane and "0" level
- Segments of display indication increase / decrease proportionally
- "0"-position can be defined (offset)
- Display illumination

TECHNICAL SPECIFICATIONS FR 77-MM SERIES

Accuracy, 3-step	2 mm, 5 mm, 9 mm
Accuracy mm-indication	± 1 mm
Display illumination	yes
Dust / water protection	IP 65

all details at geo-fennel.com

DESCRIPTION CLAMP

- Very robust metal clamp
- Bracket for squared and round poles
- Clamp fits to all of FR 77-MM receivers ever bought

All details at geo-fennel.com

The suitable **Machine Control Receivers** for your rotating lasers



62

FMR 600

Batteries, clamp for levelling staff

Art.-No.: 265000



FMR 706-M/C

Magnet and clamps, built-in rechargeable battery, charger, 12 / 24V-battery cable, hard case

Art.-No.: 260550



Remote display FRP 707

Remote display FRP 707 with connection cable

Art.-No.: 263000



FMR 800-M/C

Built-in rechargeable battery, charger, hard carrying case

Art.-No.: 264500



Remote display FRD 807

Suction pad, batteries

Art.-No.: 264540



Magnetic Support

Art.-No.: 290810

For connection to construction machinery. Allows the receiver to be easily aligned to the laser plane. Strong magnets ensure non-slip grip onto the machine. Quick release lever allows the magnetic support to be detached easily. Suitable for all brands of machine receivers using a clamp fixing system.

63

+ FMR 706-M/C + FRP 707

Magnet and clamps, built-in rechargeable battery, charger, 12 / 24V-battery cable, remote display with connection cable, hard case

Art.-No.: 260500

+ FMR 800-M/C + FRD 807

Built-in rechargeable battery, charger, hard carrying case, remote display FRD 807 with suction pad and batteries

Art.-No.: 264550

DESCRIPTION FMR 600

- Attachment to levelling staff by use of clamp or directly to the machine with built-in magnets
- LCD, LEDs and 3 different tones indicate heights
- Memory function of last received data
- Water / dust resistant

DESCRIPTION FMR 706-M/C

- Length of receiving window: 25 cm
- Connect to the machine with screw clamps or with strong magnets (both supplied in the kit)
- Detects beam from rotating laser levels of any brand
- Remote display

TECHNICAL SPECIFICATIONS

	FMR 600	FMR 706-M/C
Accuracy fine	± 5 mm	± 2 mm – ± 10 mm
Accuracy coarse	± 12,5 mm	± 5 mm – ± 23 mm
Working range	200 m	-
Receiving range	240°	-
Operating time	50 h	40 h
Power supply	4 x AA alkaline	7,2 V NiMH 2500 mAh
Dust / water protection	IP 66	IP 66

All details at geo-fennel.com

DESCRIPTION FMR 800-M/C:

- Length of receiving window: 27 cm
- Will detect the beam from any brand of rotating laser (red)
- Dust / water protected metal housing
- Wireless remote display with suction pad and integrated magnets

TECHNICAL SPECIFICATIONS

	FMR 800-M/C
General receiving range	360°
Rotation speed	rpm 300–1200
Working range class 2-Laser	250 m
Working range class 3R-Laser	350 m
Charging time	4–5 h
Complete power-off	after 60 min
Dust / water protection	IP 66

All details at geo-fennel.com

TECHNICAL SPECIFICATIONS

	FRD 807
Wireless (RF) communication range	10 m
Communication channels	3
Machine connection	Integrated magnetic pads, strong suction pad for cabin windscreen
Power supply	4 x AA alkaline
Extended size	170 x 100 x 42 mm
Weight	1,1 kg

All details at geo-fennel.com

ACCESSORIES

For Rotating and Line Lasers

Precisely fitting solutions can be further refined by supporting equipment.

geo-FENNEL expands the spectrum of precision with additional elements that add support, robustness and flexibility. We also offer additional components that redefine the measure of accuracy.

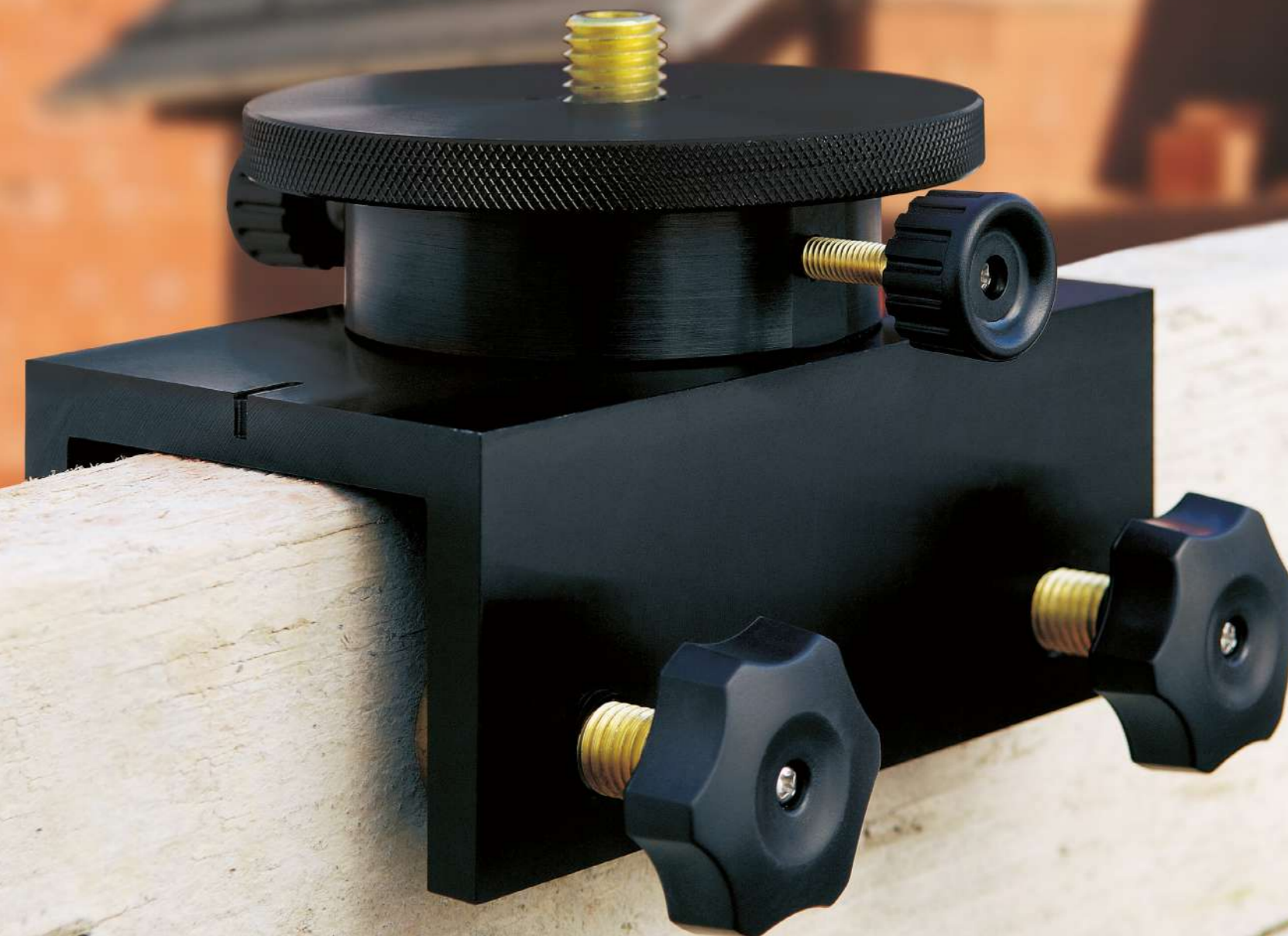

The ideal upgrade:
Our accessories for your lasers.

66

NEW
2022

Multi-functional mount MH 1

Art.-No.: 290555

DESCRIPTION MH 1

- Height adjustable platform with slow motion wheel - range 85 mm
- Platform with
- Forward / back shift 20 mm
- Left / right shift 200°
- Magnets on back side
- Screw hole for wall-attachment
- Metal plate for safe stand
- For lasers with 1/4" and 5/8" connection



Adapter WS 1

Art.-No.: 290560

DESCRIPTION WS 1

- Adapter for clamp connection at wall track for dropped ceiling installation
- Metal surface to connect with magnetic mount of line lasers
- Line laser can be moved up and down for correct height positioning



MH 1 + WS 1 Mount set

Art.-No.: 290555-S01



Floor-to-Ceiling Pillar KS 3

Art.-No.: 520100

DESCRIPTION KS 3

- Floor-to-ceiling pillar (1-leg tripod) to be fixed between floor and ceiling
- Solid construction
- 5 sections with metal thread
- Maximal length 3,40 m
- 5/8" and 1/4" adapter
- Supplied with carrying bag
- The individual poles are equipped with 5/8" threads. This enables them to be screwed onto tripods, if no ceiling surface is available.

NEW
2022

Wall bracket LH 1

Art.-No.: 290616

DESCRIPTION LH 1

- Use of laser in hanging / standing position (depending on product)
- Height adjustable range 88 mm
- Swivel-mount support rail to swing laser left / right 180°
- Free-hanging tripod mount
- Magnets on back side
- Screw hole for wall-attachment
- 1/4" and 5/8" connection

DESCRIPTION LH 2

- Use of laser in hanging /standing position (depending on product)
- Magnets on back side
- Screw hole for wall-attachment
- 1/4" and 5/8" connection



Wall and ceiling bracket WH 2

Art.-No.: 290610

DESCRIPTION WH 2

- Platform size 150 x 95 mm for fixing larger instruments
- Suitable for all geo-FENNEL-lasers
- Ideal for use indoors e.g. setting out suspended ceilings
- Cm/inch-graduation
- Precise adjustment / alignment with large slow motion wheel
- Incl. bag
- Height adjustment range: 96 mm
- 1/4" and 5/8" connection

DESCRIPTION WH 3

- Platform size 146 x 105/50 mm
- Height adjustable range of 215 mm
- Cm/inch-graduation
- 1/4" and 5/8" connection

NEW
2022

Wall and ceiling bracket WH 3

Art.-No.: 290605

67



Laser glasses red

Art.-No.: 253000



Magnetic target LS 307 red

Art.-No.: 290500

NEW
2022

Adapter A-58-14

Adapter 5/8" female into 1/4" male

Art.-No.: 290551



Grade Mount

Art.-No.: 290700



Adapter for S-digit mini

Art.-No.: 290750

Adapter FCA-L
for laser

Art.-No.: 290820

68



Laser glasses green

Art.-No.: 253001



Magnetic target LS 307 green

Art.-No.: 290501

NEW
2022

Adapter A-14-58

Adapter 1/4" female into 5/8" male

Art.-No.: 290552



Scaffold clamp holder SH 2

Art.-No.: 320610



360° Fine adjustment bracket

Art.-No.: 290760

Adapter FCA-E
for receiver

Art.-No.: 290830

69

DESCRIPTION LASER GLASSES

- Laser intensive glasses for better visibility of laser beam

DESCRIPTION MAGNETIC TARGET LS 307

- Magnetic Target with cm/inch graduation

DESCRIPTION GRADE MOUNT

- For rotating and line lasers with manual function
- For setting slopes between 0 - 90° for laser levels in manual mode
- Graduated slow motion screw
- Fits any tripod with 5/8" thread
- With bubble

DESCRIPTION SH 2

- For quick centring over the linchpin
- For all rotating lasers, however, with special marks for use with FL 275/510-Trackinglasers.

DESCRIPTION ADAPTER FOR S-DIGIT MINI +

- Adapter for connecting S-Digit mini to the Grade Mount. Allows higher accuracy to be achieved.

DESCRIPTION 360° FINE ADJUSTMENT BRACKET

- Allows a smooth 360° rotation and fine adjustment for rotating and line lasers. Final position can be clamped. Aperture for instruments with plumb down beam.
- Universal mount
- 5/8" threads (bottom female, top male)

DESCRIPTION FCA-L / FCA-E

- Adapters FCA-L for rotating lasers and FCA-E for receivers are fixed on the wall. Rotating laser plane and receiver on-level mark are to be set up at same distance to the wall by means of integrated cm / mm-graduation at both adapters
- Like this structural facings can be mounted exactly parallel
- Dedicated for use with 275HV-Tracking and FL 510HV-G Tracking in combination with receiver FR 77-MM Tracking

PIPE LASERS

Robust, waterproof, and powerful.

Our new generation of pipe lasers incorporate the latest technology for improved site performance. Handy and robust devices for the construction of drainage and pipelines in house and building construction, etc..



The handy one.



FKL 44

Pipe laser for tube diameters of 100 - 300 mm.

Handy and robust all-metall housing pipe laser for for drainage work and piping in house and object construction, etc.

FKL 44 Pipe laser

Supplied with

Target frame with targets DN 100 - 300, special target for DN 100 pipes (also target frame for FR-FKL TRACKING), RF-remote control, leg sets DN 125 / 150 / 200 / 250 / 300, Li-Ion battery and charger



Art.-No.: 454000

FR-FKL TRACKING Receiver

Supplied with

FR-FKL receiver, batteries



Art.-No.: 454050



DESCRIPTION FKL 44

- Robust aluminium housing
- Easy intuitive operation
- Fully automatic self-levelling
- Automatic beam centering
- Laser start point indication
- Clear easy-to-read OLED-Display
- RF-remote control with long working range

DESCRIPTION FR-FKL TRACKING

- Tracking function for automatic detection of the horizontal target plate center.
- Saves time at next day set up.

TECHNICAL SPECIFICATIONS

	FKL 44	FR-FKL TRACKING
Self-levelling range	± 5°	-
Accuracy (horizontal)	± 5 mm / 100 m	± 2 mm / 100 m (in total)
Left / right tracking	± 10°	-
Laser diode / Laser class	red / 2	-
Working range	120 m	50 m
Grade range	-20 % to +30 %	-
Temperature range	-20 °C to +50 °C	-10°C to +45°C
Dust / water protection	IP 68	IP 67

All details at geo-fennel.com

Straight and advanced.



74

FKL 55 and FKL 55-GREEN

Advanced mechanical engineering technology, temperature stability and grade technology. Extremely good visibility of OLED display with large figures. Long-range IR remote control with 100 m working range.

Laser spot direction setting: quick shifting by continued pressing respective button at both laser or remote control. Rugged, waterproof, powerful, easy-to-use and comprehensive range of standard accessories.

DESCRIPTION FKL 55 + FKL 55-GREEN

- Robust metal housing
- Easy intuitive operation
- Fully automatic self-levelling
- Automatic beam centering
- Laser start point indication
- Clear easy-to-read OLED display
- IR remote control with long working range
- Integrated rechargeable batteries

TECHNICAL SPECIFICATIONS

	FKL 55 (LC 3R)	FKL 55 (LC 2)	FKL 55-GREEN (LC 3R)
Self-levelling range	± 5°	± 5°	± 5°
Accuracy (horizontal)	± 5 mm / 100 m	± 5 mm / 100 m	± 5 mm / 100 m
Left / right tracking	± 4°	± 4°	± 4°
Laser diode / Laser class	red / 3R	red / 2	green / 3R
Working range	200 m	120 m	200 m
Grade range	-20 % to +30 %	-20 % to +30 %	-20 % to +30 %
Dust / water protection	IP 68	IP 68	IP 68

All details at geo-fennel.com

*depending on room brightness
**depending on the alignment of the laser

FKL 55 LC 2

Supplied with
Look at scope of delivery FKL 55 LC (3R)

Art.-No.: 455520

FKL 55 LC 3R

Supplied with Target frame with target DN 150-300, container, IR remote control, leg set DN 200 / 250 / 300 / 400 / 500, adapter for 3-leg set up, rechargeable battery, charger, battery case for alkaline batteries, target DN 400-500



Art.-No.: 455500

FKL 55-GREEN LC 3R

Supplied with Target frame with target DN 150-300, container, IR remote control, leg set DN 500, leg set DN 200 / 250 / 300 / 400 / 500, adapter for 3-leg set up, rechargeable battery, charger, battery case for alkaline batteries, target DN 400-500



Art.-No.: 456500

Suitable Accessoires:



Universal mount for FKL 55 and FKL 55-GREEN

Art.-No.: 455100

- Levelling base with height adjustable mount for use
- in manhole
- in or in front of pipes with large diameter
- with 5/8" female thread for tripod connection



SURVEYING INSTRUMENTS

Always right in the middle

Many years of experience - an important factor for the quality of a measuring device. In addition, the certainty of being able to rely on absolutely reliable measurement results under all conditions.



For daily use on the construction site.



GFN 1, 400 gon
Automatic Level

GFN 1 level, adjustment pin, carrying case
Art.-No.: 200200



GFN 1, 400 gon
Set

GFN 1 level with carrying case, aluminium tripod, 5 m levelling staff, in carton
Art.-No.: 200201



N 32, 400 gon Set
Automatic Level

N 32 level with carrying case, aluminium tripod, 5 m levelling staff
Art.-No.: 200532

GFN 1, 360°
Automatic Level

GFN 1 level, adjustment pin, carrying case
Art.-No.: 200205

GFN 1, 360°
Set

GFN 1 level with carrying case, aluminium tripod, 5 m levelling staff, in carton
Art.-No.: 200206

N 32, 360° Set
Automatic Level

N 32 level with carrying case, aluminium tripod, 5 m levelling staff
Art.-No.: 200533

TECHNICAL SPECIFICATIONS

	GFN 1	N 32
Mean error 1 km double levelling	± 1,5 mm	± 2 mm
Telescope magnification	32 x	32 x
Objective diameter	36 mm	36 mm
Shortest focussing distance	0,4 m	0,3 m
Working range of compensator	± 15'	-
Horizontal circle	400 gon / 360°	400 gon / 360°
Dust / water protection	IP 54	IP 54

DESCRIPTION GFN 1

- Robust metal housing with handle for comfortable handling
- Bubble reading mirror
- Optical sight for quick alignment to a levelling staff
- 32 x magnification

DESCRIPTION N 32

- Robust metal housing
- Supplied in carton comprising N32, 5 m levelling staff and tripod for convenient storage and delivery

Always measured precisely with our high-quality engineers' level.



GFN 10, 360°
High quality engineering level

GFN 10 level, adjustment pin, plumb bob, case
Art.-No.: 200225

GFN 10, 400 gon
High quality engineering level

GFN 10 level, adjustment pin, plumb bob, case
Art.-No.: 200220

GFN 10, 400 gon
Set

GFN 10 level, adjustment pin, plumb bob, aluminium tripod, 5 m levelling staff, case
Art.-No.: 200220-S01

TECHNICAL SPECIFICATIONS

	GFN 10
Mean error 1 km double levelling	± 1,0 mm
Telescope magnification	32 x
Objective diameter	40 mm
Shortest focussing distance	0,6 m
Accuracy	-
Working range of compensator	± 15'
Measurement units	400 gon / 360°
Dust / water protection	IP 65

DESCRIPTION GFN 10

- Robust metal housing with handle for comfortable handling
- Reticle in wedge-shape for most accurate reading
- Well protected internal circle
- Compensator test button
- Bubble reading mirror



Electronic Theodolites – easy to use.



For measuring horizontal, vertical and zenith angles. For use in engineering, civil engineering and general construction.

Coaxial laser beam integrated in the telescope and focusable laser beam. 2-axis compensator of the target and cross axis. For the automatic correction of small residual inclinations of the vertical angles.

Special version for the alignment of masts and antennas with special reticle optionally available.



FET 220
Electronic Theodolite

Tribach, rechargeable battery, charger, battery compartment for alkaline batteries, container

Art.-No.: 313000

FET 220K-L
Electronic Theodolite

Tribach, rechargeable battery, charger, battery compartment for alkaline batteries, container

Art.-No.: 313100

TECHNICAL SPECIFICATIONS

	FET 220	FET 220-KL
Telescope magnification	30 x	30 x
Compensator	no	yes, 2-axis
Laser point finder	no	yes, focusable
Laser plummet	± 2 mm to 1,5 m	2 mm to 1,5 m
Accuracy	20" (6 mgon)	2" (0,6 mgon)
Minimum reading	10" (3 mgon)	1" (0,2 mgon)
Measuring units	400 gon / 360°	400 gon / 360°
Dust / water protection	IP 54	IP 54

DESCRIPTION

- 2 large easy-to-read LCDs
- Laser plummet for easy set up over the ground point
- Illumination of LCD and field of view
- Horizontal circle: hold-function, 0-set at any desired position, clockwise / anti-clockwise reading
- Vertical circle: reading in gon / degrees / percent
- For measuring horizontal, vertical and zenith angles.
- For use in engineering, civil engineering and general construction



FET 500, 400 gon
Construction Theodolite

Art.-No.: 350000

FET 500, 360°
Construction Theodolite

Art.-No.: 350360



DESCRIPTION FET 500

- Robust starter instrument for universal use
- Built-in optical plummet
- Circular bubble, plate level
- Telescope vial
- Circle orientation device
- Available in 400 gon or 360°

TECHNICAL SPECIFICATIONS

	FET 500
Telescope magnification	20 x
Objective diameter	30 mm
Shortest focussing distance	1,2 m
Direct reading	0,1 gon
Estimation	10 mgon
Temperature range	-40 °C to +50 °C
Weight	2,0 kg

Now surveying can be **easy and affordable!**



82

The **geo-FENNEL GNSS-Antenna FGS Lite** with geo-FENNEL Survey Software supports the user in a variety of simple surveying tasks.

The **geo-FENNEL Survey Software** is a simplified, android-based application software that can handle simple measurement tasks. Stake out points and lines, area calculation and the calculation of point coordinates.

FGS Lite
GNSS-Antenna

incl. Software geo-FENNEL Survey
incl. Outdoor Tablet
incl. GPS-Antennenstab G 20

FGS Lite GNSS receiver, GAT 300 GNSS antenna, antenna pole G20, battery and charging cable, bracket for FGS Lite, antenna connection cable for FGS Lite, hard case, android software «geo-FENNEL Survey»

Art.-No.: 740100

TECHNICAL SPECIFICATIONS

FGS LITE

GPS	L1, C/A, L2C, L2P
SBAS	WAAS, EGNOS, MSAS, GAGAN
Accuracy SBAS	1 m 3D RMS
OZSS	reserved
GALILEO	E1, E2, E5
BEIDOU	B1, B2
GLONASS	L1C/A, L1P, L2C/A, L2P
Channels	352
Bluetooth	4.0, for Windows and Android
Dust / water protection	IP 54

THE NEW FGS LITE

The geo-FENNEL Survey Software supports all geo-FENNEL GNSS antennas, whether in UHFMode or in a CORS with on-line transformation. Data can be picked up from a FTP-Server which is automatically created by the software. Whether site surveying or setting out work, the data can be transferred or read in quickly and precisely from the terminal device.

IDEALLY SUITED FOR

- Earth moving / road construction
- Mining
- Contractor
- Garden / landscaping
- Archaeologists
- Municipality
- Water management
- Agriculture / forest
- Assessor national resources



Software on point.

The comprehensive geo-FENNEL Survey Software is well equipped for daily surveying tasks.

The easy menu operation quickly grants access to the desired surveying tasks: From point recording, stake out, complex drawings to quick area determination is all quickly accessible. Even without a special surveyor's training you will be able to fully master these surveying tasks like a pro.



LASER DISTANCE METERS

Nothing stays unmeasured

Distances, areas and volumes: the new GeoDist® generation unites pinpoint geo-FENNEL precision and simplified navigation for an optimal measurement result. This is what smart working of tomorrow looks like.



Laser Distance Meters Outline

	GEODIST® 30 300130	GEODIST® 50 300150	GEODIST® 60 GREEN 300160	GEODIST® 80 300180	GEODIST® 100-TOUCH 300100	GEODIST® 600LR 300600	GEOTAPE 2 IN 1 300710
Laser class	red / 2	red / 2	green / 2	red / 2	red / 2	-	red / 2
Measuring range*	0,05 - 30 m	0,2 - 50 m	0,2 - 60 m	0,2 - 80 m	0,2 - 100 m	to 600 m	to 20 m
Accuracy distance measurement**	± 2 mm	± 2 mm	± 2 mm	± 2 mm	± 2 mm	± 0,5 m	± 2 mm
Accuracy slope settings	-	-	+/- 0,3°	+/- 0,3°	+/- 0,3°	-	-
Measuring units	m / ft / in / ft+in	m / ft / in / ft+in	m / ft / in / ft+in	m / ft / in / ft+in	m / ft / in / ft+in	-	m / ft / in / ft+in
Power supply	2 x AAA Alkaline	2 x AAA Alkaline	NiMH	NiMH	NiMH	3V 1 x CR2	Li-Ion
Temperature range	0°C to 40°C	0°C to 40°C	0°C to 40°C	0°C to 40°C	0°C to 40°C	0°C to 40°C	0°C to 40°C
Dust / water protection	IP 54	IP 54	IP 65	IP 65	IP 65	IP 54	-
Page	87	87	88	89	90	91	87

*Reduced working range under unfavourable measuring conditions

** Typical accuracy, increased under unfavourable measuring conditions



GeoDist® 30 Extremely small and lightweight

Holster, batteries

Art.-No.: 300130



GeoDist® 50 Allrounder at indoor construction sites

Holster, batteries

Art.-No.: 300150



GeoTape 2in1 Laser Tape

USB-charging cable, integrated Li-Ion-batteries

Art.-No.: 300710

DESCRIPTION GEODIST 30

- Area / volume / distance
- Illuminated display
- Point of reference: front, rear

DESCRIPTION GEODIST 50

- Area / volume / distance
- Maximum / minimum measurement
- Addition / subtraction
- Painter function
- Display illuminated
- Point of reference: front, rear
- Pythagoras functions
- Data storage (last 10 values)

TECHNICAL SPECIFICATIONS

	GEODIST 30	GEODIST 50	GEOTAPE 2IN1
Measuring range*	0,05 - 30 m	0,2 - 50 m	to 20 m
Accuracy distance measurement **	± 2 mm	± 2 mm	± 2 mm
Measuring units	m / ft / in / ft+in	m / ft / in / ft+in	m / ft / in / ft+in
Laser diode / laser class	red / 2	red / 2	red / 2
Power supply	2 x AAA Alkaline	2 x AAA Alkaline	Li-Ion
Dust / water protection	IP 54	IP 54	-

All details at geo-fennel.com

*Reduced working range under unfavourable measuring conditions
** Typical accuracy, increased under unfavourable measuring conditions

Our new **GeoDist®** product range!

**NEW
2022**



GeoDist® 60-GREEN

Clear view thanks to green laser

NiMH batteries, USB charging cable, holster, hand strap

Art.-No.: 300160

With its green laser target point, the **GeoDist® 60 Green** creates clear conditions and measurements from up to 60 metres, even in unfavourable visibility conditions.



DESCRIPTION GEODIST 60-GREEN

- Distance / area / volume
- Continuous measurement / minimum / maximum
- Addition / subtraction
- Illuminated display
- 1/4" tripod connection
- Slope measurement 4 x 90
- Measuring plane: front, rear, tripod connection
- Pythagoras functions
- Automatic distance measurement (via tilt measurement)
- Automatic height measurement (via inclination measurement)
- Memory (20 last measured values)

TECHNICAL SPECIFICATIONS GEODIST 60-GREEN

Measuring range*	0,2 - 60 m
Accuracy distance**	± 2 mm
Accuracy	+/- 0,3°
Measuring slope	m /ft / in / ft+in
Laser diode / laser class	green / 2
Power supply	NiMH
Dust / water protection	IP 65

All details at geo-fennel.com

*Reduced working range under unfavourable measuring conditions
** Typical accuracy, increased under unfavourable measuring conditions

**NEW
2022**



GeoDist® 80

For precision at full distance

NiMH batteries, USB charging cable, holster, hand strap

Art.-No.: 300180

The **GeoDist® 80** opens up even extensive outdoor areas easily with a pointfinder camera.

DESCRIPTION GEODIST 80

- Distance / area / volume
- Continuous measurement / minimum / maximum
- Addition / subtraction
- Offset +/- and stakeout
- Colour display / rotatable
- Pointfinder camera with 4 x zoom
- 1/4" tripod connection
- Slope measurement 4 x 90
- Measuring plane: front, rear, tripod connection
- Pythagoras functions
- Automatic distance measurement (via tilt measurement)
- Automatic height measurement (via tilt measurement)
- Trapezoidal measurements
- Area measurement triangle / circle
- Volume measurement cylinder
- Memory (1000 last measurements)
- Data export via bluetooth & USB
- GeoDist®Connect App (Android and Apple)

TECHNICAL SPECIFICATIONS GEODIST 80

Measuring range*	0,2 - 60 m
Accuracy distance**	± 2 mm
Accuracy	+/- 0,3°
Measuring slope	m /ft / in / ft+in
Laser diode / laser class	red / 2
Power supply	NiMH
Dust / water protection	IP 65

All details at geo-fennel.com

*Reduced working range under unfavourable measuring conditions
** Typical accuracy, increased under unfavourable measuring conditions

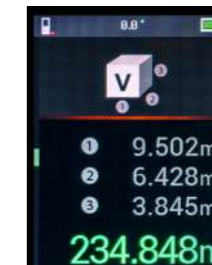



**NEW
2022**

GeoDist® 100-TOUCH
For precision at full distance

NiMH batteries, USB charging cable, holster, hand strap

Art.-No.: 300100

The top model with the intuitive touch screen operation - Operate the laser distance meter just like you do with your smartphone.



DESCRIPTION GEODIST 100-TOUCH

- Distance / area / volume
- Continuous measurement / minimum / maximum
- Addition / subtraction
- Offset +/- and stakeout
- Colour display / rotatable
- Pointfinder camera with 4 x zoom
- 1/4" tripod connection
- Slope measurement 4 x 90
- Measuring plane: front, rear, tripod connection
- Point-to-point measurement (3D)
- Pythagoras functions

- Automatic distance measurement (via tilt measurement)
- Automatic height measurement (via tilt measurement)
- Trapezoidal measurements
- Area measurement triangle / circle
- Volume measurement cylinder
- Memory (1000 last measurements)
- Data export via Bluetooth & USB
- GeoDist® Connect App (Android and Apple)

TECHNICAL SPECIFICATIONS

GEODIST 100-TOUCH

Measuring range*	0,2 - 100 m
Accuracy distance**	± 2 mm
Accuracy	+/- 0,3°
Measuring slope	m / ft / in / ft+in
Laser diode / laser class	red / 2
Power supply	NiMH
Dust / water protection	IP 65

All details at geo-fennel.com

*Reduced working range under unfavourable measuring conditions
** Typical accuracy, increased under unfavourable measuring conditions



GeoDist® 600LR
Laser distance meter for range and speed measurement

Holster, battery

Art.-No.: 300600

- Speed measurements up to 300 km/h
- Single and continuous measurement
- Built-in angle sensor
- Measurements of horizontal distances
- Measurement of height differences
- Auto power off
- Flagpole scanning, perfect for golf players
- Golf trajectory compensation
- Measures in meter and yard

TECHNICAL SPECIFICATIONS

GEODIST 600LR

Measuring range*	to 600 m
Accuracy distance**	± 0,5 m
Power supply	3V 1 x CR2
Dust / water protection	IP 54

All details at geo-fennel.com

*Reduced working range under unfavourable measuring conditions
** Typical accuracy, increased under unfavourable measuring conditions

MEASURING INSTRUMENTS

Precision meets innovation

No matter how difficult the conditions you encounter on a construction site – with our products, easy and efficient measurement is possible in every situation. They set standards for measurement results and provide a high level of quality through the combination of the most modern production technologies with the care and attention provided by our technical experts.





EasyWheel M20
Measuring Wheel

Measuring wheel, carrying case with shoulder strap

Art.-No.: 120



M 10
Precision Measuring Wheel

Art.-No.: 110

Suitable Accessoires:



Bag
for M10 / M10S

Art.-No.: 010



Case
for M10 / M10S

Art.-No.: 011

M 10S
Precision Measuring Wheel

Art.-No.: 141



Rubber Tape
3 m x 16 mm

Art.-No.: M345012

Rubber Tape
5 m x 25 mm

Art.-No.: M345014

Rubber Tape
8 m x 25 mm

Art.-No.: M345015



Fast Speed Tape
30 m x 12,5 mm

Art.-No.: M313030

Fast Speed Tape
50 m x 12,5 mm

Art.-No.: M313050



DESCRIPTION EASYWHEEL M20

- The compact and durable multi-purpose measuring wheel
- Easy-to-read display
- Foldable for easy storage and transportation
- Brake and «0» reset button incorporated into handle

TECHNICAL SPECIFICATIONS

EASYWHEEL M20	
Accuracy	± 0,1%
Measuring distance	0 - 9.999,9 m
Wheel circumference	1 m
Extended size	1000 (L) x 140 mm (L)
Folded size	510 (L) x 140 mm (L)
Weight	1,8 Kg

All details at geo-fennel.com

DESCRIPTION M 10

- Wheel circumference 1 m
- Clamp for wheel
- Robust support allows M 10 to stand upright
- Dirt remover
- Precision counter with „0“ reset
- Sturdy spokes offer low resistance to wind ensuring ease of use
- The highly visible colour of the wheel aids operator safety during use on roads
- Weight 2,7 kg

DESCRIPTION M 10S

- Same as M 10, however:
- Heavy model with double-disk wheel made of metal
- Weight 3,4 kg

DESCRIPTION RUBBERTAPE

- Standard measuring tape
- Blister packed in presentation display
- Conforms to CE class II

DESCRIPTION FAST SPEED TAPE

- 3 x speed rewind
- Nylon coated steel tape
- Abrasion resistant and unbreakable
- Ergonomically designed to be comfortable and easy to use



S-Digit mini +

Padded bag, batteries

Art.-No.: 610010



S-Digit 60 WL+

Padded bag, batteries

Art.-No.: 640010



S-Digit multi +

Padded bag, batteries

Art.-No.: 630010



S-Digit 120 WL+

Padded bag, batteries

Art.-No.: 640110



S-Digit 60 +

Padded bag, batteries

Art.-No.: 620010



A-Digit 50

Padded bag, batteries

Art.-No.: 650050



Multi-Digit Pro +

Padded bag, batteries

Art.-No.: 600010



Scale Master Pro XE Digital Plan Measurer

Padded bag, batteries

Art.-No.: 6135

USB cable for Scale Master Pro XE

USB cable for data transfer to PC

Art.-No.: 5001B

DESCRIPTION S-DIGIT MINI +

- Different signal tones when approaching 0° / 90° and continuous tone at 0° / 90°
- Inclination direction indication
- Zero position re-set at any position
- Automatic digit inversion for overhead measurements
- HOLD function to freeze measurement
- Illuminated display
- Magnetic housing
- 1/4" thread for camera tripod

DESCRIPTION S-DIGIT MULTI +

- Same as S-Digit mini +, however:
- 180° rotatable display
- Visible laser beam to extend working range

DESCRIPTION S-DIGIT 60 +

- Same as S-Digit mini +, however:
- Visible laser beam to extend working range
- Magnetic base

DESCRIPTION S-DIGIT 60 WL+ + S-DIGIT 120 WL+

- Same as S-Digit mini +, however:
- 180° rotatable display
- 1 or 2 recessed hand grips for ergonomic use

DESCRIPTION A-DIGIT 50 + A-DIGIT 75

- Angle measurement
- Supplement angle
- Easy mitre angle
- Compound angle mode
- Available in length of 50 cm and 75 cm

DESCRIPTION MULTI DIGIT PRO +

- Displays angle and inclination simultaneously
- Different signal tones when approaching 0° / 90° and continuous tone at 0° / 90°
- Inclination direction indication
- Zero position reset at any position
- Automatic digit inversion for overhead measurements
- 180° rotatable display
- Visible laser beam to extend working range
- HOLD function to freeze measurement
- Illuminated display
- Magnetic base
- 1/4" thread for camera tripod
- 180° lock to extend the unit to 1 m length
- Arm can be locked in any position
- Magnetic base

DESCRIPTION SCALE MASTER PRO XE

- Digital plan measurer for area and quantity calculation in seconds. Direct display of length, area and room measurements without calculating.
- 91 pre-programmed scales
- 8 scales for self-programming (e.g. for plans that are not to scale, reduced or enlarged plans)
- Add, subtract, store constants and built-in counter



EasyFix 5 m
Telescopic Rule

Art.-No.: 451



Laser EasyFix 5 m
Telescopic Rule

Art.-No.: 452

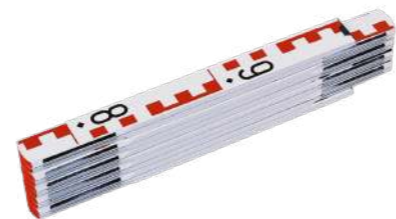

Surveyors' Folding Rule
2 m, upright

Art.-No.: 412

Surveyors' Folding Rule
3 m, upright

Art.-No.: 410

DESCRIPTION EASYFIX 5 M

- Threaded pins for top and bottom plate for measuring to corners and edges
- Carrying case
- Easy reading of measuring display
- Auto-lock on each section when fully extended
- Incorporates two vials
- cm/mm-graduation on bottom section
- Retracted length 104 cm
- Max. length 5 m
- Weight 2 kg

DESCRIPTION LASER EASYFIX 5 M

- Telescopic rule with incorporated measuring tape
- Each section can be clamped
- Universal adapter for laser receiver. Receiver can be fixed with on-level mark on top of the rule.
- The height of the receiver (on-level mark) can be easily read at measuring display
- Maximum length 500 cm
- Retracted length 121.5 cm
- Incorporated circular bubble
- Weight 2.7 kg
- Incl. case

DESCRIPTION SURVEYORS' FOLDING RULES

- Finest wood quality with strong joint springs
- Length of section: 37,5 cm
- Front side: levelling graduations (E reading) 1 m black, 1 m red
- Reverse side: mm graduation in black
- Available in 2 m and 3 m lengths



FPL L-5 (LC 2)
Positioning Laser

Art.-No.: 519005

FPL L-10 (LC 2)
Positioning Laser

Art.-No.: 519010

FPL L-20 (LC 3R)
Positioning Laser

Art.-No.: 519020

DESCRIPTION FPL L POSITIONING LASER

- Projects a clearly visible laser line
- Power supply: 220 V with plug and switch
- Multi-functional mount (rotatable and swivelling)

DESCRIPTION FPL C POSITIONING CROSS LASER

- Projects a clearly visible laser line
- Power supply: 220 V with plug and switch
- Multi-functional mount (rotatable and swivelling)

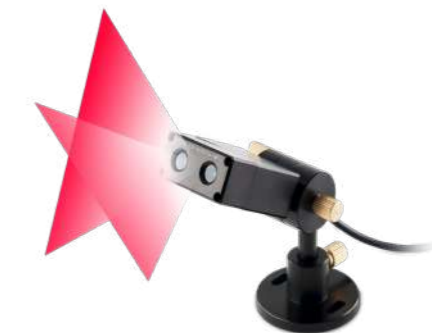

FPL C-5 (LC 2)
Positioning Cross Laser

Art.-No.: 519105

FPL C-10 (LC 2)
Positioning Cross Laser

Art.-No.: 519110

FPL C-20 (LC 3R)
Positioning Cross Laser

Art.-No.: 519120

TECHNICAL SPECIFICATIONS	FPL L-5	FPL L-10	FPL L-20	FPL C-5	FPL C-10	FPL C-20
Laser wave length	635 nm	635 nm	635 nm	635 nm	635 nm	635 nm
Integrated laser diode	5 mW	10 mW	20 mW	5 mW	10 mW	20 mW
Laser output power	< 1 mW	< 1 mW	< 5 mW	< 1 mW	< 1 mW	< 5 mW
Laser class	2	2	3R	2	2	3R
Focusing	0 – 10 m	0 – 10 m	0 – 10 m	10 m	10 m	10 m
Fan angle	84°	84°	84°	120°	120°	120°
Dust / water protection	IP 41	IP 41	IP 41	IP 43	IP 43	IP 43

All details at geo-fennel.com

ENVIROMENTAL INSTRUMENTS

The degree of professionalism:
Extremely high.

Suitable for a wide range of applications including electrical, food preparation, automotive, maintenance, construction, health and safety the environmental measurement devices from geo-FENNEL are reliable partners wherever physical values such as temperature and humidity must be precisely determined. They are characterized by their ease of use and intuitive operation – taking precise measurement to achieve visible and tangible results.



Metal, wood and live power lines -
there is no problem for our detectors.



NEW
2022



80 mm
Metall, magnetisch
Ferrous metal
Métaux, ferreux

20 mm
Holzunterkonstruktion
Wood stud
Sous-construction en bois

50 mm
AC
110-230 V

FWS 80 Wall detector

For detection of metal, wood and living wires in ceiling, wall and floor.

Art.-No.: 800770



FMD 60 Metal Detector

8 x AA alkaline batteries, case

Art.-No.: 800800



FH 1 Headphone

Art.-No.: 800810



DESCRIPTION FWS 80

- Detection up to 80 mm depth, depending on material
- Indication of center of object (wood and metal)
- AC detection (live wires) and alert at any mode
- Automatic calibration
- Illuminated display

TECHNICAL SPECIFICATIONS

Maximum measuring depth*	Ferrous metal (80 mm), non-ferrous metals (50 mm), wires / conductors (live wiring) (50 mm), wood stud (20 mm)
Display	LCD 2.2"
Measuring units	cm, inch
LED indication	red, yellow, green
Power supply	3 x AAA
Display illumination	yes
Automatic calibration	yes
Indication of center of object	yes (wood, metal)



All details at geo-fennel.com

*depending on object type and size, as well as the condition and material of the subsoil

DESCRIPTION FMD 60

- Detection of all kinds of metals
- Handle adjustable
- Length 114 – 139 cm
- Headphone jack

DESCRIPTION HEADPHONE FH 1

- For the use of FMD 60 in loud surroundings
- Padded earcups and headband

TECHNICAL SPECIFICATIONS FMD 60

Measuring depth	60 cm
Measuring disc	Ø 24 cm
Dust / water protection	IP 67
Weight	3,3 kg (with bag in box)

All details at geo-fennel.com





FVE 100 Video Borescope

Video borescope, 1 m flexible gooseneck probe, TV cable, USB cable, charger, magnet, hook, mirror, container

Art.-No.: 800700



FVE 150 Video Borescope

Video borescope, 1 m flexible gooseneck probe, TV cable, USB cable, charger, magnet, hook, mirror, 4 GB SD-card, container

Art.-No.: 800710



Gooseneck probes Ø camera head of 17 mm

Art.-No.: 800750 1 m
Art.-No.: 800751 2 m
Art.-No.: 800754 4 m

Gooseneck probes Ø camera head of 9 mm

Art.-No.: 800752 1 m
Art.-No.: 800753 2 m
Art.-No.: 800755 4 m



FIRT 550-Pocket Infrared Thermometer

Case, battery

Art.-No.: 800001



FIRT 1000 DataVision Infrared Thermometer

Battery, USB cable, mini tripod, Type-K temperature probe, case

Art.-No.: 800030



FIRT 800-Pocket Infrared Thermometer

Case, battery

Art.-No.: 800002



FIRT 1600 Data Infrared Thermometer

Battery, USB cable, mini tripod, Type-K temperature probe, case

Art.-No.: 800020

DESCRIPTION FVE 100:

- Water proof camera head and probe
- 1 m long flexible gooseneck probe with camera head for the optical inspection of inaccessible areas
- Camera head with LED lighting
- Immediate transfer of the colour image to the large LCD display
- 180° image rotation at the press of a button
- Direct transfer of image to television or notebook
- Hook and magnet attachments for object retrieval
- Angle mirror attachment to "view around corners"
- Powerful Li-Ion battery with charger

DESCRIPTION FVE 150:

- Same as FVE 100, however:
- Internal memory or SD-card to store images and video sequences
 - Date and time indication on the display
 - Transmission of video clips / images onto television or PC for editing or documentation

TECHNICAL SPECIFICATIONS

	FVE 100	FVE 150
CAMERA HEAD		
Viewable angle	0° and 180°	0° and 180°
Focal length	6 – 7 cm	6 – 7 cm
Viewable distance	5 – 15 cm	5 – 15 cm
Diameter of camera head	17 mm	17 mm
Light source	LED	LED
Display size	3"	3,2"
Display resolution	960 x 240 Pixel	320 x 240 Pixel
Probe length	100 cm	100 cm
Dust / water protection	IP 67	IP 67

All details at geo-fennel.com

DESCRIPTION FIRT 550 / 800 POCKET

- For non-contact measurement with laser target.
- Quick measurements for:
 - Surfaces which are difficult to reach
 - Moving or rotating objects
 - Electrified parts
 - Chemicals
 - Hot objects

DESCRIPTION FIRT 1600 DATA

- For non-contact temperature measurement with laser target
- 150 ms fast sampling with 1 % accuracy
- High temperature range
- Built in dual laser pointers for accurate targeting
- Permanent measuring
- Compatible with all standard connector Type-K thermocouples
- USB interface
- Memory for 99 measurements
- Easy transmission of data to PC via USB interface

DESCRIPTION FIRT 1000 DATAVISION

- Same as FIRT 1600 Data, however:
- 2.2" TFT colour LC display
 - Memory socket for micro-SD cards
 - Integrated camera for images (JPEG) and video (AVI)
 - Date / time function
 - Measurement of air humidity for determination of dew point

TECHNICAL SPECIFICATIONS

	FIRT 550	FIRT 800	FIRT 1000	FIRT 1600
D(istance):S(pot)	12:1	10:1	50:1	50:1
Measuring spot at 100 cm	80 mm	100 mm	20 mm	20 mm
Emissivity	0,1 – 1,0	0,1 – 1,0	0,1 – 1,0	0,1 – 1,0
Laser pointer	yes, dual	yes, dual	yes, dual	yes, dual
Laser class	2	2	2	2
Response time	< 1 sec	< 1 sec	< 150 ms	< 150 ms

All details at geo-fennel.com



FTI 300
Thermal Imaging camera

Li-ion battery and charger, USB-cable for data transfer and charging, hard case

Art.-No.: 800040

Automatic indication of hot / cold spot with configurable alarm function.

PIP-function for blending of visible and infrared image (0-100%) for optimized orientation in the picture.

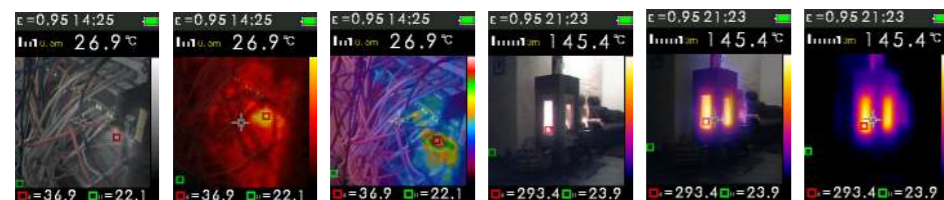

DESCRIPTION FTI 300

- 6 colour palettes
- Memory for 6000 images / data transfer to PC for subsequent analysis
- Temperature measurement range -20°C to +300°C

TECHNICAL SPECIFICATIONS

	FTI 300
Temperature range	-20°C to +300°C
IR sensor resolution	32 x 31 Pixel
Thermal sensitivity	< 0,15°C (150 mK)
Field of view (FOV)	40° x 40°
Focusing	fixed

All details at geo-fennel.com



FHT 70 DataLog
Temperature and Humidity Data Logger

3.6 V lithium battery, software, clamshell

Art.-No.: 800120

Measures temperature and air humidity. LCD with date, time, temperature, humidity, limit value.



FHT 60
Humidity and Temperature Meter

Case, battery

Art.-No.: 800100

FHT 100
Humidity and Temperature Meter

Case, battery

Art.-No.: 800110

DESCRIPTION FHT 70 DATALOG

- Internal memory for 32.700 readings (3 x 10.900)
- Software for analysis

DESCRIPTION FHT 60

- Fast measurement of relative humidity and temperature

DESCRIPTION FHT 100

- Same as FHT 60, however:
- Dewpoint temperature measurement for recognition of mold growth and wet bulb

TECHNICAL SPECIFICATIONS

	FHT 70 DATALOG	FHT 60	FHT 100
Measuring range (temperature)	-40 °C to 70 °C	-20 °C to +60 °C	-30 °C to +100 °C
Measuring range (relative humidity)	0 – 100 % RH	0 – 100 % RH	0 – 100 % RH
Logging rate	1 sec, 24 h	-	-
Fast response time	-	yes	yes
Illuminated display	-	yes	yes

All details at geo-fennel.com



FHM 10
Moisture Meter

Batteries

Art.-No.: 800310

DESCRIPTION FHM 10

- Measurement principle: electrical resistance
- Dual display for wood and construction materials
- Replaceable 8 mm measuring pins
- Protective cap with integrated function and battery check
- Automatic power-off
- Rugged housing



FHM 20
Moisture Meter

Moisture and temperature probe, padded bag, 2 x spare measuring pins, 2 x AAA batteries

Art.-No.: 800320

DESCRIPTION FHM 20

- Measurement principle: electrical resistance
- External moisture measurement probe
- External temperature probe: at measurement with moisture and temperature probe the moisture measurement is carried out with automatic temperature compensation. This leads to a higher accuracy.
- 8 mm measuring pins (replaceable)
- Protective cap with integrated calibration check
- Battery status indicator
- Automatic power-off (adjustable time)



FFM 100
Moisture Detector

Batteries

Art.-No.: 800650

DESCRIPTION FFM 100

- Quick measurement of humidity in building materials without destruction of the surface
- Indication of minimum / maximum values
- Sensor type: metal spheroid



FTA 1
Thermometer- Anemometer

Art.-No.: 800450

- Sensor with 120 cm cable
- 9 V alkaline battery
- Container



FCT 1 Data
Coating Thickness Tester

Art.-No.: 800460

- 2 x AAA batteries
- USB cable
- Software
- Calibration accessories
- Case



FMM 5
5-in-1 Digital Multimeter

Art.-No.: 800600

- All-purpose probe TP-500
- Set of batteries
- Case
- Testing cable



FSM 130 +
Sound Level Meter

Art.-No.: 800210

- Case
- Battery



FLM 400 Data
Lux Meter

Art.-No.: 800510

- 9 V battery
- Photo detector
- USB cable
- Software
- Carrying case



FT 1300-1
K-Type Thermometer with single input

Art.-No.: 800400

- Flexible wire probe TP-300
- Set of batteries
- Case



FGD 1
Gas Leak Detector

Art.-No.: 800470

- Batteries



FT 1000-Pocket
Digital Thermometer

Art.-No.: 800420

- Set of batteries
- Incorporated all-purpose probe



FT 1300-2
Professional K-Type Thermometer with dual input

Art.-No.: 800410

- Flexible wire probe TP-300
- Set of batteries
- Case



TP-300
Flexible wire probe

Art.-No.: 800900



NR-88B
Flexible steel probe

Art.-No.: 800902



NR-38
Air temperature probe

Art.-No.: 800905



TP-500
All-purpose probe (7 cm)

Art.-No.: 800901



TP-550
All-purpose probe (15,5 cm)

Art.-No.: 800906



NR-31B
Surface temperature probe

Art.-No.: 800903



NR-33
Right angle surface temperature probe

Art.-No.: 800904

TRIPODS AND LEVELLING STAFFS

Always stable

Precision begins with the appropriate basis. The basis of an accurate measurement is a base that adapts to the conditions. In this way, various inclinations, stable work on substrates and secure adhesion can lead to an optimal measurement result. With the geo-FENNEL tripods and levelling staffs you can adapt to the surrounding conditions to make your measurements precise.



Light Elevating Tripods made of aluminium

FS 10
Elevating Tripod

incl. 30 cm centre column, rotating head

Art.-No.: 302000



FS 13
Elevating Tripod

incl. 120 cm centre column, rotating head

Art.-No.: 304000

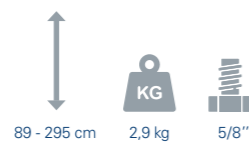

FS 12
Elevating Tripod

incl. 30 cm centre column, rotating head

Art.-No.: 303000



FS 14
Camera Tripod

Rotating head and tilttable

Art.-No.: 301000



FS 30-XS
Elevating Tripod

Art.-No.: 165

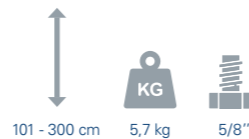

Heavy Elevating Tripods with high stability

FS 30-S
Elevating Tripod

Art.-No.: 155



FS 30-M
Elevating Tripod

Art.-No.: 158



FS 30-L
Elevating Tripod

Art.-No.: 156

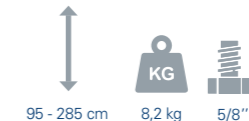

FS 50-M
Elevating Tripod

Art.-No.: 164



FS 50-L
Elevating Tripod

Art.-No.: 166

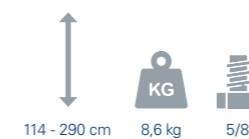

FS 30-XL
Elevating Tripod

Art.-No.: 159

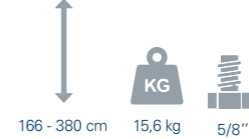

112

113

Universal Tripods for all situations



Builder's Tripod BT
Aluminium Tripod with flat head

Art.-No.: 161



FS 20
Elevating Tripod with flat head

Art.-No.: 151



FS 20-D
Elevating Tripod with domed head

Art.-No.: 157



Tripod Floor Stand
Protection stand

Art.-No.: 170

Wooden Tripods High quality and robust



FS 24
Wooden Tripod with flat head

Art.-No.: 154



FS 24-M W/S
Wooden Tripod with flat head Ø 17 cm

Art.-No.: 162 W/S

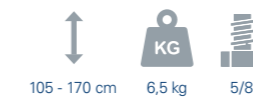

FS 24 W/S
Wooden Tripod with screw clamp system

Art.-No.: 154 W/S



FS 23-D
Aluminium Tripod with domed head

Art.-No.: 153

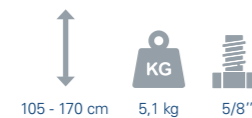

FS 23
Aluminium Tripod with flat head

Art.-No.: 152



FS 23 W/S
Aluminium Tripod with screw clamp system

Art.-No.: 152 W/S



Metal Ranging Pole RP 2
Package of 6, in bag

Art.-No.: 800

1 m Extension
for RP 2

Art.-No.: 810



Ranging Pole Tripod RPT 1
with case

Art.-No.: 820



TN 14, 4 m
Levelling staff



Levelling staff made of strong aluminium tubes

Art.-No.: 484

TN 15, 5 m
Levelling staff



Levelling staff made of strong aluminium tubes

Art.-No.: 485

BS 15-0, 5 m
Levelling staff



Levelling staff made of strong aluminium tubes / rear face graduated in mm with "0" beginning at the bottom

Art.-No.: 486-BS

TN 15-0, 5 m
Levelling staff



Levelling staff made of strong aluminium tubes / rear face graduated in mm with "0" beginning at the bottom

Art.-No.: 486

TN 20-Kombi, 2,4 m
Levelling staff



Levelling staff for reading the height differences with the correct sign

Art.-No.: 482

Suitable Accessoires:

Circular bubble LR 7
for TN 14 / 15 / 15-0

Art.-No.: 370

Case
for TN 14 / 15 / 15-0

Art.-No.: 480



ACCESSORIES

Always new challenges to conquer

The versatility of measuring instruments from geo-FENNEL can be increased significantly by using our wide range of precisely coordinated surveying accessories. Regardless of the profession or application, the know-how from many decades of experience in the field of measurement technology and surveying resides in our products.





Marking Spray

with 12 cans of 500 ml:

Art.-No.: 901	fluo orange
Art.-No.: 902	fluo red
Art.-No.: 903	fluo blue
Art.-No.: 904	fluo yellow
Art.-No.: 905	fluo green
Art.-No.: 906	fluo pink
Art.-No.: 911	red
Art.-No.: 913	yellow
Art.-No.: 915	white

F6

Two-way radio



Two-way radio, rechargeable battery, charger, belt clip, hand strip

Art.-No.: 870000



F6-EM

Earphone / clip microphone

Art.-No.: 870150



F6-HM

Hand microphone

Art.-No.: 870100



Surveyors' Folding Frame, DIN A4

Art.-No.: 541 Wood

Art.-No.: 542 Plastic, red

Art.-No.: 543 Plexiglass, clear view



Surveyors' Folding Frame, DIN A3

Art.-No.: 531 Wood



Optical square J2

Optical square

Art.-No.: 242 Plastic Accuracy: better 2'



Optical square F 1/1'

Optical square

Art.-No.: 210 Plastic Accuracy: better 1'

Art.-No.: 211 Metal Accuracy: better 1'



LR 1

Rod level made of metal (adjustable)

Art.-No.: 310



LR 5

Rod level made of wood

Art.-No.: 350



LR 34

Rod level made of metal (adjustable)

Art.-No.: 330



LR 39

Rod levels

Art.-No.: 390 Plastic

Art.-No.: 391 Metal

FE 1A

Zip case

Art.-No.: 012

FE 1B

Press stud case

Art.-No.: 013

MIXERS

Directly in action

Performance beyond measure. The application possibilities of mixers from geo-FENNEL are as unique as your needs. The portfolio combines the powerful performance with ergonomic design and handling. The machines are adapted to different materials and therefore always find the optimal solution for your project.



Ergonomic and powerful - the appropriate mixer for every application



**NEW
2022**

FM 1200 Mixer

Stirring rod H2-120 MM
Art.-No.: M800501

FM 1801 Mixer

Stirring rod H2-140 mm
Art.-No.: M800508

FM 1800 Mixer

Carrying case, stirring rod H2-140 mm, stirring rod H3-120 mm
Art.-No.: M800507

Our mixers - suitable for all applications

Ergonomic design, strong performance. Powerful mixers for paint, mortar, concrete, etc. Ideally suited for construction sites.

TECHNICAL SPECIFICATIONS

	FM 1200	FM 1800 & 1801
Power	1200 W	1800 W
Over-voltage protection	yes	yes
Capacity	15-35 kg	FM 1800 = 15-50 kg / FM 1801 = 15-35 kg
Speed adjustable	150-300 and 300-650 rpm	150-300 and 300-650 rpm

All details at geo-fennel.com



Stirring rod H2 For sticky and viscous materials

Tile adhesive, bonding mortar, joint compound, ready-mixed plaster, floor screed, cement compounds, fillers

Article	Capacity	Diameter	ART-NO:
H2 120G	15 - 25 kg	120 mm	M800590
H2 140G	30 - 50 kg	140 mm	M800591
H2 160G	35 - 60 kg	160 mm	M800592



Stirring rod H3 For liquid, very viscous and fibrous materials in large quantities

Wall paint, varnish, glaze, joint sealing compound, cements, lime, plaster, concrete, filler, floor screed

Article	Capacity	Diameter	ART-NO:
H3 L120G	15 - 25 kg	120 mm	M800597
H3 L140G	25 - 35 kg	140 mm	M800596
H3 L160G	30 - 60 kg	160 mm	M800599



Stirring rod H4 For liquid materials

Wall paint, emulsion paint, tile adhesive, glue, wallpaper paste

Article	Capacity	Diameter	ART-NO:
H4 114G	15 - 40 kg	120 mm	M800598



Stirring rod H7 For liquid materials

Wall paint, emulsion paint, paste, bitumen, sludge, joint sealing compound, filler, bonding agent

Article	Capacity	Diameter	ART-NO:
H7 100G	15 - 25 kg	100 mm	M800594

All stirring rods have a length of 600 mm and M14 thread.



**NEW
2022**

Extension 100 mm x M14

To extend paddle for more working ergonomics by avoiding a stooped working posture.

Art.-No.: M800581



**NEW
2022**

Extension 200 mm x M14

To extend paddle for more working ergonomics by avoiding a stooped working posture.

Art.-No.: M800582

QUALITY AND SERVICE

Information and Support

Many can sell. But only a few offer professional advice and comprehensive service. At geo-FENNEL, not only the listed products and services are always available. Qualified specialists are always ready to advise you throughout the country and abroad - regardless of whether you have questions about the application, the technology or the sale.



Quality with foresight. Laser measuring tools and surveying equipment supplied by geo-FENNEL.

geo-FENNEL – Surveying Instruments without limits

Located in Hesse, Germany, we are a mid-sized company which has gained a good reputation as a supplier for laser measuring technology and surveying equipment. Today we are in the front row when users ask for laser measuring devices. Our products are recognised all over the world and we currently deliver them to more than 70 countries worldwide. Our indispensable company philosophy is to provide our customers with innovative, precise and reliable products and to offer first class service. High quality, a good and fair price-performance ratio as well as fast delivery count among our principles. Our cooperative partnership with our customers is essential for us and our international orientation is a main strategy.

Our extensive experience has convinced customers, for many years.

Our quality standard

geo-FENNEL instruments are tested and calibrated using tools and equipment traceable through DKD* accreditation back to national standards. These test procedures conform to DIN ISO standards.

*DKD = German Calibration Office

DKD

Quality is our benchmark. Service is our pledge.

Service that is something to be proud of.

Many can sell but only a few can back this up with professional advice and extensive service facilities. At geo-FENNEL, our products and services are available at all times, home and abroad and our fully trained personnel are ready to support you with advice at any time. Whether you have questions concerning application, technology or sales we are committed to provide the assistance you require.

State-of-the-art manufacturing technology, the care and continuous training of our employees and our efficient work ethic guarantee you a consistent high level of after sales service. Should a repair become necessary, our repair and spare part departments are ready to help – this applies to our complete product range..

Guaranteed First Class.

We strive to provide the user measuring instruments that offer all the advantages which characterize geo-FENNEL products: easy-to-use, cost effective, accurate measuring performance under almost all conditions with the highest reliability. We offer 2 years guarantee on all products.

However, in the unlikely event that a problem should occur, simply contact your dealer. He will ensure that the product is quickly restored to full working order, or will replace it with a new one. Quick and easy.

Our assortment

Laser Surveying Instruments

- Rotating Lasers
- Cross and Line Lasers
- Pipe Lasers
- Laser Distance Meters

Classic Surveying Instruments

- Automatic Levels
- Theodolites
- Total stations
- GPS-Systems

Accessoires

- Laser accessoires
- Surveying accessories
- Measuring tools
- Environmental measuring instruments



Laser classification according to DIN EN 60825-1:2014.

geo-FENNEL laser products are classified into either laser class 2 or 3R. Their laser class is specified in our technical data. Please refer to the latest version.

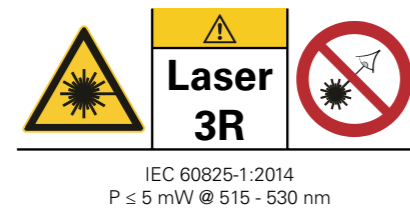
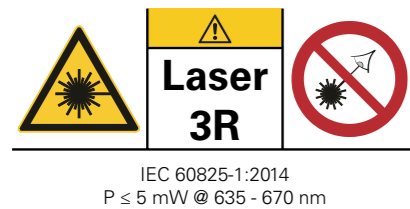
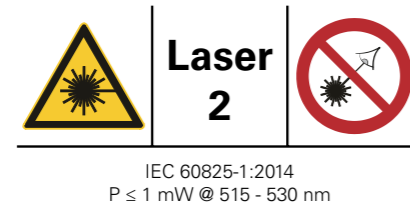
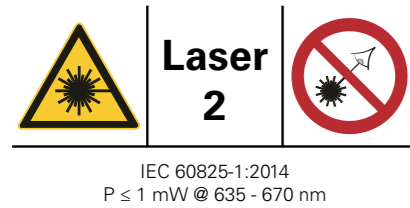

GEO-FENNEL Line Laser

The complete range is classified in laser class 2 and offered in 4 visibility classes:

Standard	e. g. Square Liner II	Working range visibility 10 m
HP (High-Power)	e. g. FL 1000HP	Working range visibility 20 m
SP (Selection PRO)	e. g. Geo6X SP	Working range visibility 30 m
SP (Selection PRO) - Green	e. g. FLG 66-Xtreme Green SP	Working range visibility 40 m

GEO-FENNEL ROTATIONSLASER

Our complete range is available within the laser class 2 classification.

LK 2 Instruments with laser class 2

The laser product can be used without further safety precautions (the relevant safety instructions are described in our user manuals). The eye is protected by the normal human aversion response and the blinking reflex of the human eye to a bright radiant source.

LK 3R Instruments with laser class 3R

The legal requirement for using laser class 3R products varies from country to country. The user is responsible for compliance to the national standards and regulations. The use of laser class 3R products may require registration with a local authority and the appointment of a health and safety operative. Special protection measures may be necessary as laser class 3R products have a higher laser output power. The positive effect of this is to increase the performance of the products for long range reception with receivers and improved visibility when using without a receiver. geo-FENNEL offers various rotating and pipe lasers with laser class 3R.

Product functions and product highlights

geo-FENNEL lasers have many features which help to carry out safe and comfortable work on construction sites. Some of these features are explained below.



Zonal control

Zonal control with electronic beam screen avoids spurious measurements caused by crossing laser planes and reflections. Furthermore it greatly increases site safety.



Li-Ion battery technology

This technology has great advantages when compared against alkaline and NiMH rechargeable batteries:

- 100 % power until fully discharged
- Top-up charging possible as no memory effect will occur
- Low self discharge when not in use.



PowerSwitch Technology

Rotating lasers with our unique PowerSwitch technology have the power of a class 3R laser but in a certified class 2 laser. The result is no output loss of working range or visibility of the laser line.



Tracking Function

The laser plane of the rotating laser is automatically centered to the receiver „on-grade“ position. This makes alignment tasks over long distances extremely easy, e.g. while doing scaffolding work.



Automatic TILT function

This is a measurement safety function. If the level of the instrument is disturbed it will relevel itself (within the self-levelling range of 5°). If the level is disturbed at a large range (for example if a tripod leg has moved) a height offset can be caused. This will be avoided by the TILT function. The instrument will shut off even within the self-levelling range. This function is activated automatically after the self-levelling procedure is completed.



Vibration-Wind-Security (VWS)

This is also a measurement safety function. It allows continuous operation during periods of vibration and wind. If a significant movement occurs the laser stops rotating and the laser beam is flashing. The VWS-Mode is combined with the automatic TILT Function.



Remote control function

The remote control function can be switched off to avoid interference from other instruments that are being used on the same construction site.



geo-FENNEL knowledge base – useful information about laser measuring technology.

As specialists in the field of laser measuring equipment we would like our customers to benefit from our many years of experience, providing you with useful explanations relating to various topics in the field of laser technology. This will make using our instruments easier, safer and a more profitable experience.

IP-dust / water protection according to DIN EN 60529

The degree of protection of an instrument's housing is defined by the indicator "IP" (Ingress Protection) followed by a two-digit code.

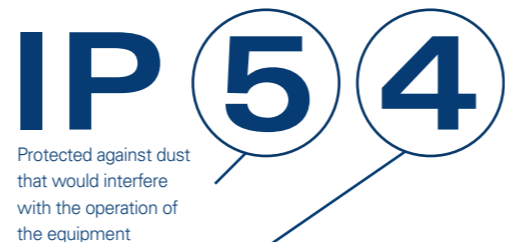

FIRST DIGIT – PROTECTION AGAINST SOLID PARTICLES

- 0 No protection
- 1 Protected against solid particles with a diameter greater than 50 mm
- 2 Protected against solid particles with diameter greater than 12 mm
- 3 Protected against solid particles with diameter greater than 2,5 mm
- 4 Protected against solid particles with diameter greater than 1 mm
- 5 Protected against dust that would interfere with the operation of the equipment
- 6 Dust tight

SECOND DIGIT – PROTECTION AGAINST WATER

- 0 No protection
- 1 Protected against dripping water
- 2 Protected against dripping water, when the housing is tilted at an angle of up to 15°
- 3 Protected against sprayed water up to an angle of 60°
- 4 Protected against splashed water from any direction
- 5 Protected against water projected from a nozzle
- 6 Protected against water projected from powerful jets from any direction
- 7 Protected against temporary immersion
- 8 Protected against permanent submersion in water

Precision begins with visibility

The human eye can see the different wavelengths (measuring unit 'nm') of the visible colour spectrum in different intensities. The optimum is at 555 nm. Green light is situated in the middle of this range and can be perceived much higher compared to red light.

Therefore green lasers have benefits when used without a receiver. The visibility is much better when working in a bright environment, over long distances or on dark surfaces. Previously the disadvantages of green lasers were a limited temperature range, shorter battery life, the laser class classification, as well as the significantly higher price.

geo-FENNEL have now introduced an innovation in the field of rotating lasers: The rotating lasers FLG 245HV-Green and FLG 245HV-GREEN TRACKING are equipped with advanced laser diode technology offering the following advantages:

- Fully usable temperature range of -20 °C to +50 ° C (the same as red laser diode)
- Classification in laser class 2 due to special control electronics
- Equal or slightly better visibility compared to the previous laser class 3R version.
- Due to the laser class 2 classification the laser can be used without any regulatory complications on all construction sites.

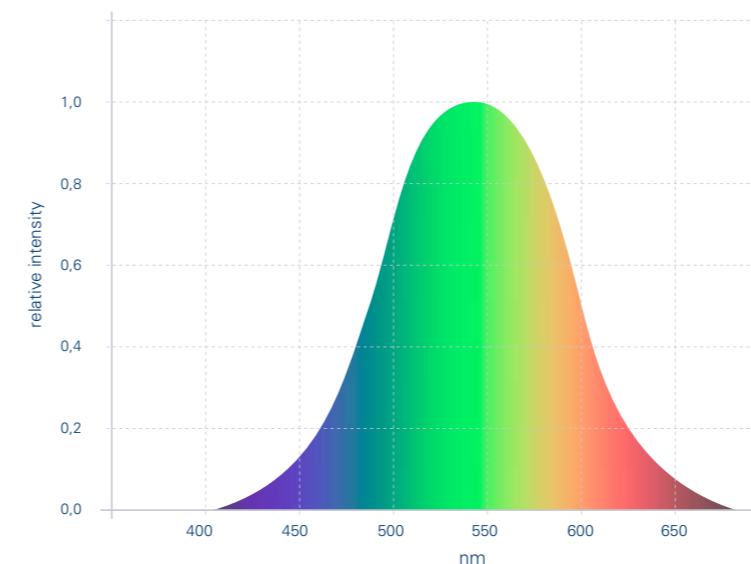

geo-FENNEL F6 Two-way Radio

The F6 is a PMR 446 channel (Private Mobile Radio) licence free Two-way Radio.

Extract from this:

General assignment of frequencies in the 446.0 MHz - 446.1 MHz frequency range for use by the general public for radio applications for voice communications with handheld radios.

This type of radio can be used by anyone anywhere in the EU registration area totally fee free. They can have a maximum RF output power of 500mW and have an approx. maximum range of 5 km.

SET ASIDE THE BAND 446.0 - 446.1 MHz FOR A PMR 446 SERVICE, WITH A CHANNEL PLAN BASED ON 12,5 KHZ SPACING:

- | | |
|---------------------------|---------------------------|
| Channel 1 = 446,00625 MHz | Channel 5 = 446,05625 MHz |
| Channel 2 = 446,01875 MHz | Channel 6 = 446,06875 MHz |
| Channel 3 = 446,03125 MHz | Channel 7 = 446,08125 MHz |
| Channel 4 = 446,04375 MHz | Channel 8 = 446,09375 MHz |



maxi
Sales Display

Width 100 cm, depth 50 cm, height 200 cm

Art.-No.: 111000

- Made of metal with a large glass door
- Wooden presentation area for 6 products, which can be secured underneath with a 5/8" tripod screw
- 1 small glass display (left), lockable
- 1 shelf in the bottom cabinet which is also lockable
- On left and right side tripods, levelling rods and floor-to-ceiling pillar KS 3 can be positioned



mini
Made of metal

Width 50 cm, depth 40 cm, height 50 cm

Art.-No.: 110000

- Metal Housing
- On wooden presentation area 3 products can be fixed with 5/8" tripod screw
- Display with slideable glass door for arrangement of further products
- Lockable for security against thievery
- Can be integrated in existing Tegometall shelving system



basic
Display out of laminated wood

Width 50 cm, depth 25 cm, height 30 cm

Art.-No.: 110050

With geo-FENNEL's «Target Group Product Presentation System» you can achieve even more success at the point-of-sale!

Because the presentation system lets you address your target groups on the basis of their individual technical requirements in combination with an attractive presentation.

Product labels give end users the most important product data and information and thus promoting independent sale of the devices. With selected product accessories you can achieve cross-selling effects within the various target group presentation systems. Target group presentation systems are available for the following product ranges: Generalist, Drywall Construction, Landscaping and Civil Engineering, Tiling, Painting, and Electrical Work. Of course, it is possible to combine different target group presentation systems. Simply talk to your geo-FENNEL sales representative for more information. He or she will be pleased to give you more details and help you to select the appropriate geo-FENNEL target group presentation systems.

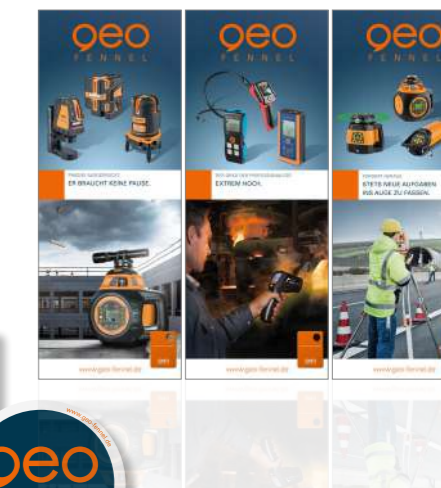

Professional in presentation

Professional in presentation – geo-FENNEL also supplies posters and wall charts for exhibitions or various labels for sales displays and authorized dealers:

Help to reach your customers with the marketing material from geo-FENNEL.

geo-FENNEL online

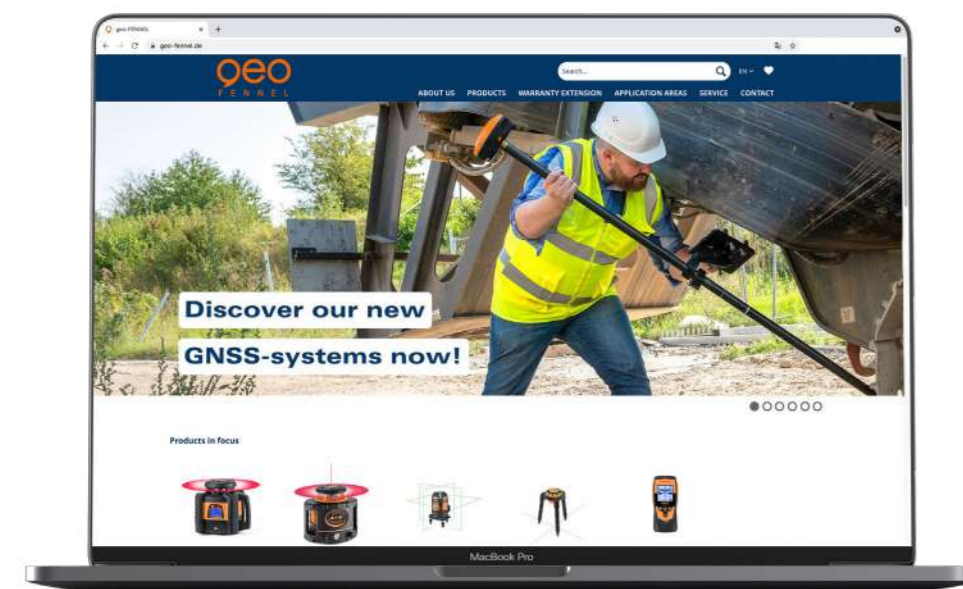

Still strong on the Internet.

The Internet will continue to be a strong component of our communication strategy. Here we are continuously expanding our service - both for you as a dealer with important sales information and for information about laser measurement technology, surveying supplies and environmental measurement technology for your end customers.

You know best which special requirements you have for our surveying instruments. Our website - optimised for your computer, tablet PC or smartphone - provides you with detailed information and data on our products, catalogue downloads and news. So that you can also reach us on the move at any time.

geo-fennel.com

